

# HISTORICAL COLLECTION

## WORLD WAR II



**STURMGESCHÜTZ IV**  
 IN SERVICE - 1944 - 1945  
 PLACE OF ORIGIN - GERMANY  
 TYPE - ASSAULT GUN  
 WEIGHT - 23T (50700LB)  
 ARMOUR - 10-80MM (0.4' - 3.1')  
 ARMAMENT - 1x 7,5cm STUK 40 L/48,  
 1x 7,92mm (.312') MG 34  
 ENGINE - MAYBACH HL 120 TRM, 220kW (300HP)  
 MAX SPEED - 38KM/H (23,6MPH)  
 RANGE - 210KM (130mi) ON THE ROAD  
 CREW - 4



Sturmgeschütz IV  
 Sd.Kfz. 167

2576

**PAD PRINTED**  
**NO STICKERS**

**Printed in EU**



**WARNING: CHOKING HAZARD-**  
 Toy contains small parts.  
 Not for children under 3 years.

952

**STURMGESCHÜTZ IV**

SCALE 1:28



1

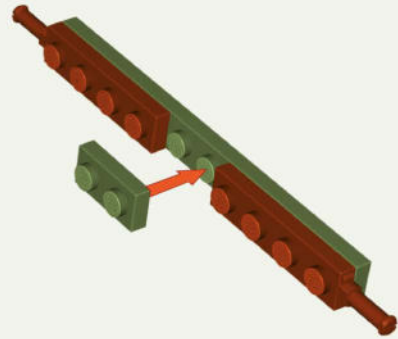

2

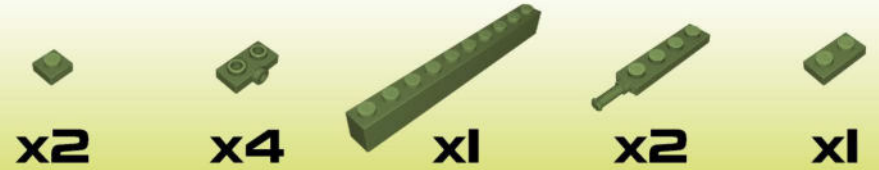
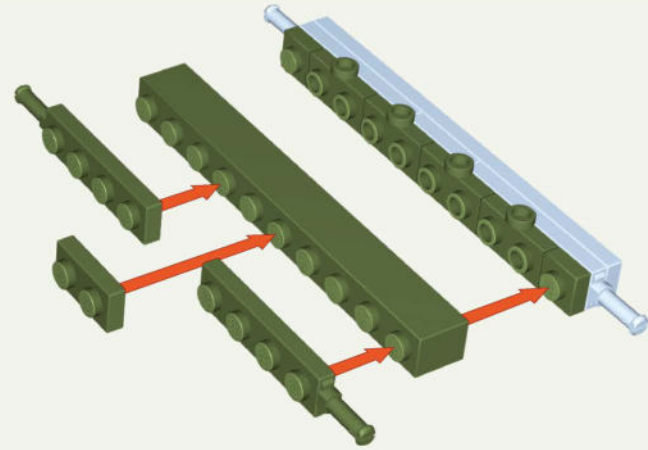

3

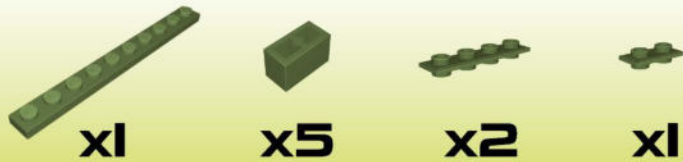
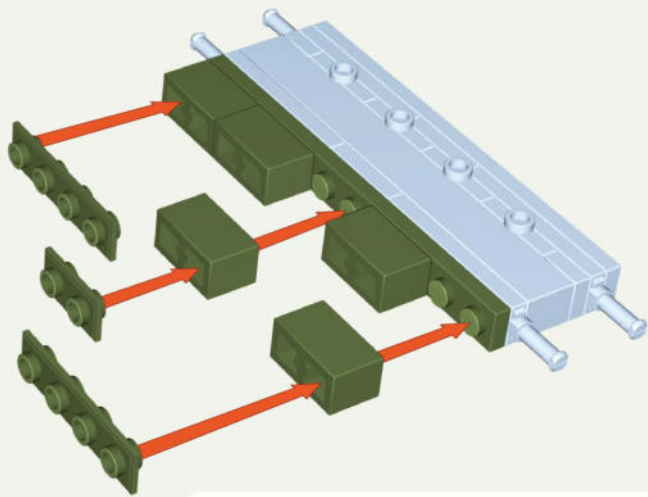

4

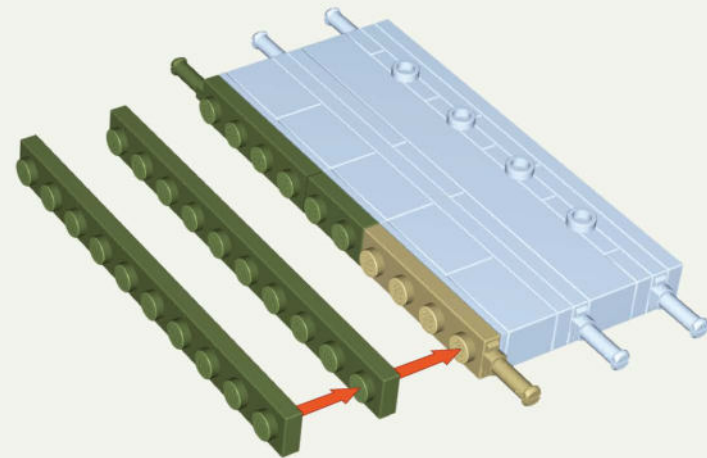



5

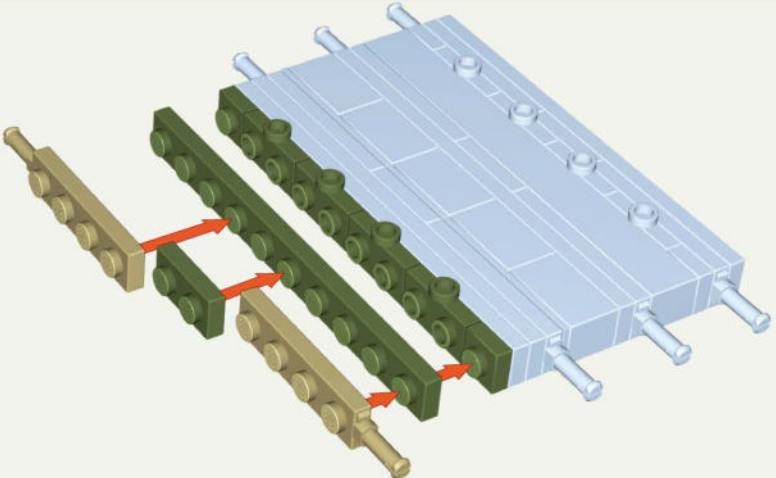

6

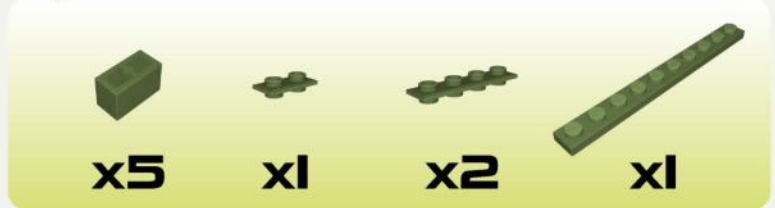
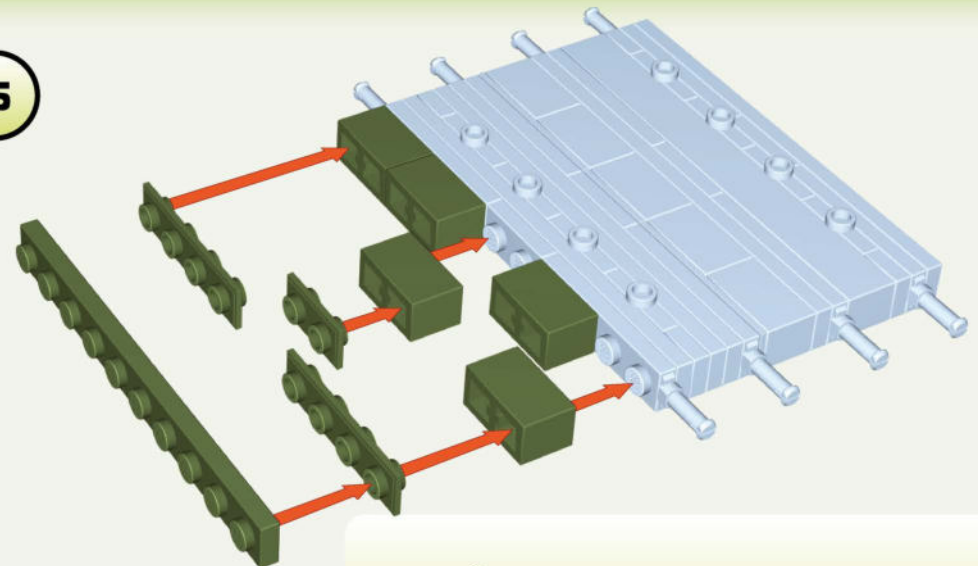

7

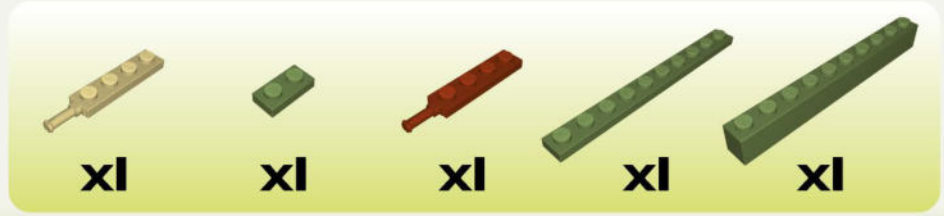
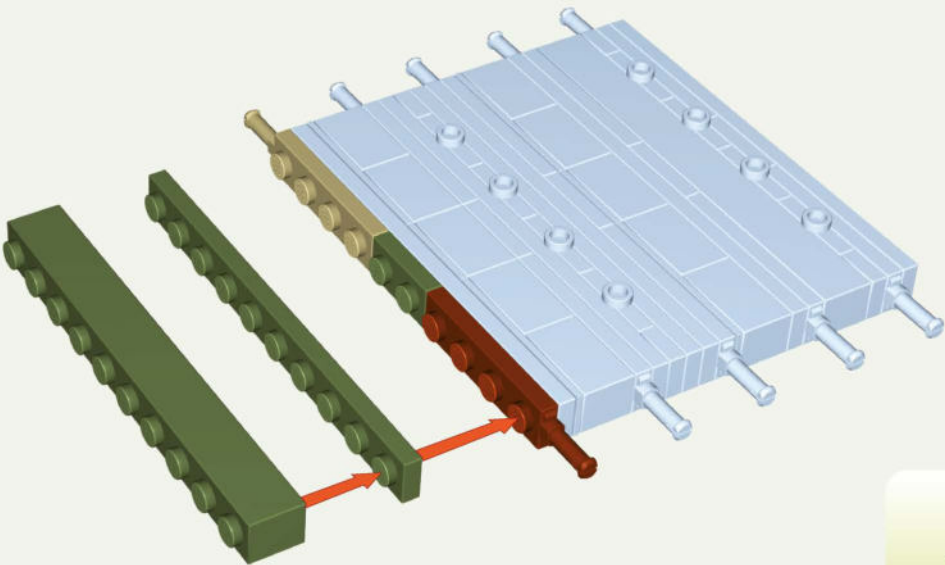



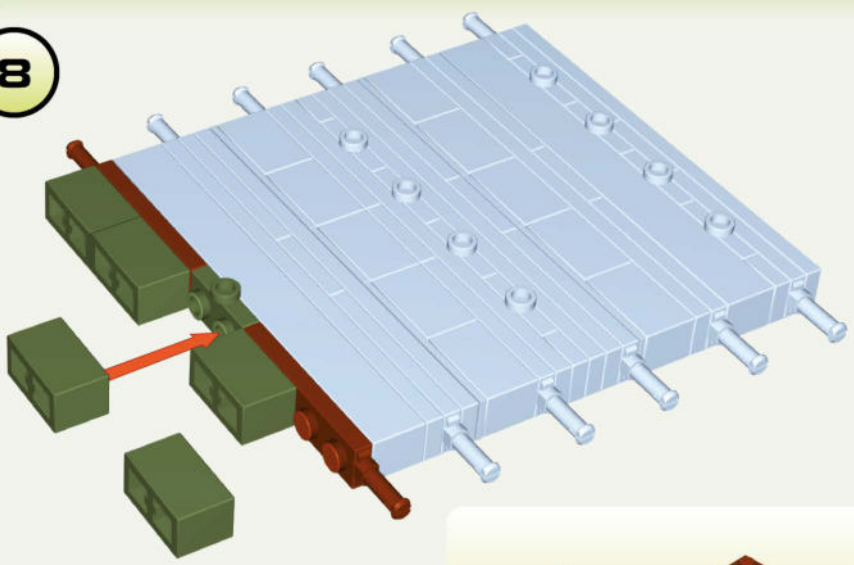



8

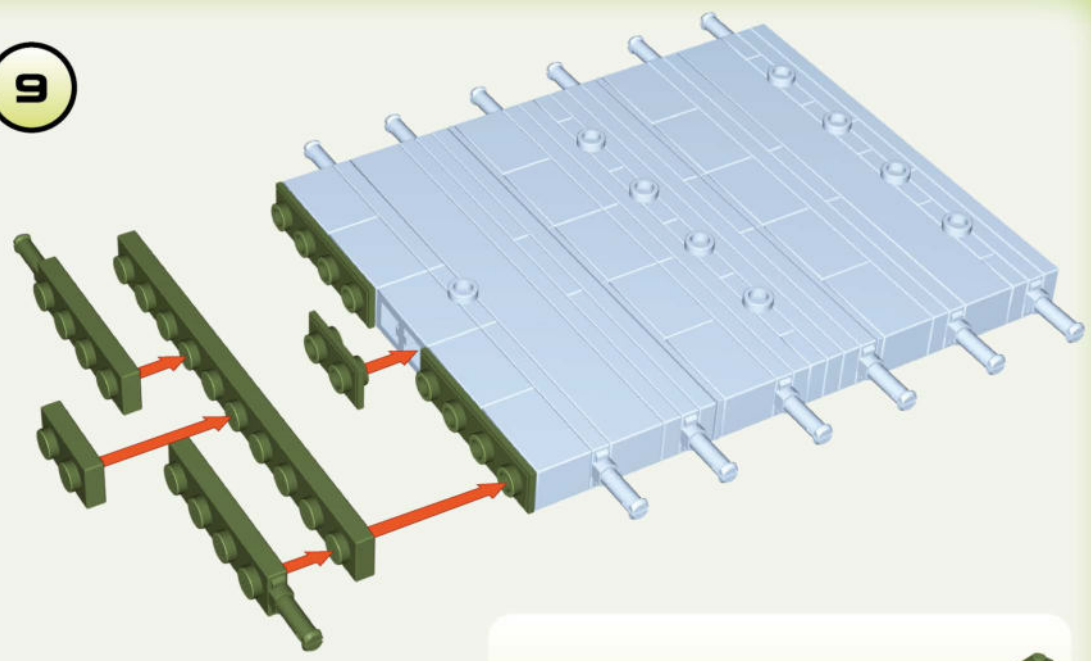

 x1  
  x2  
  x5





9

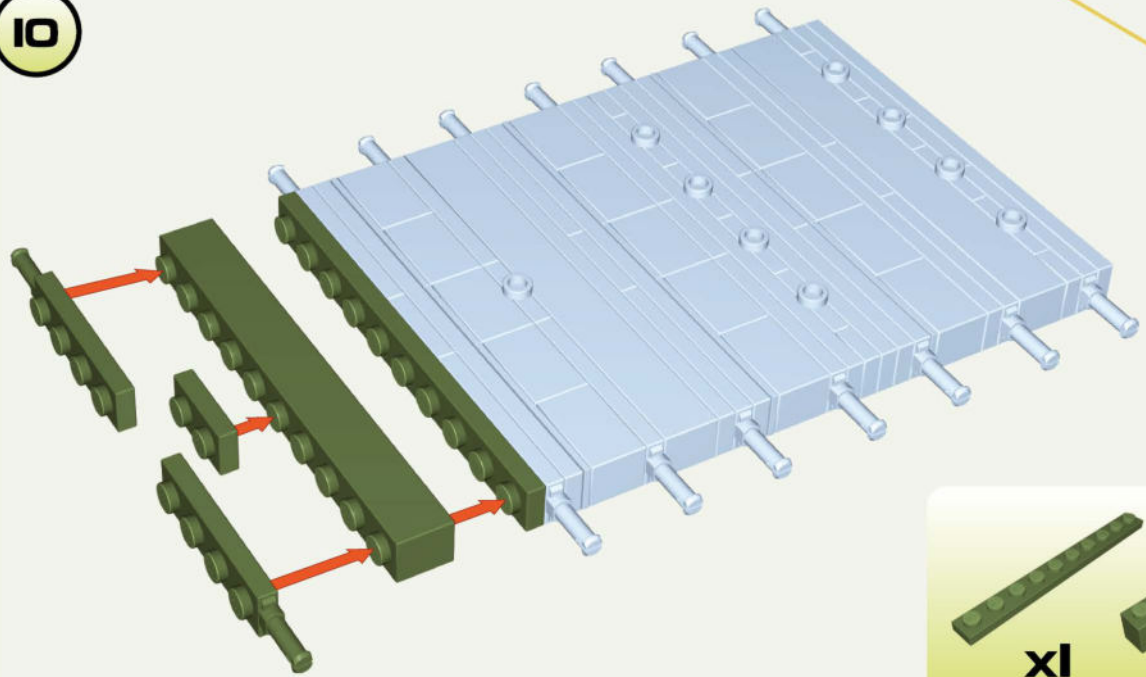

 x2  
  x1  
  x1  
 x2  
  x1

10



 x1  
  x1  
  x1  
  x2



11

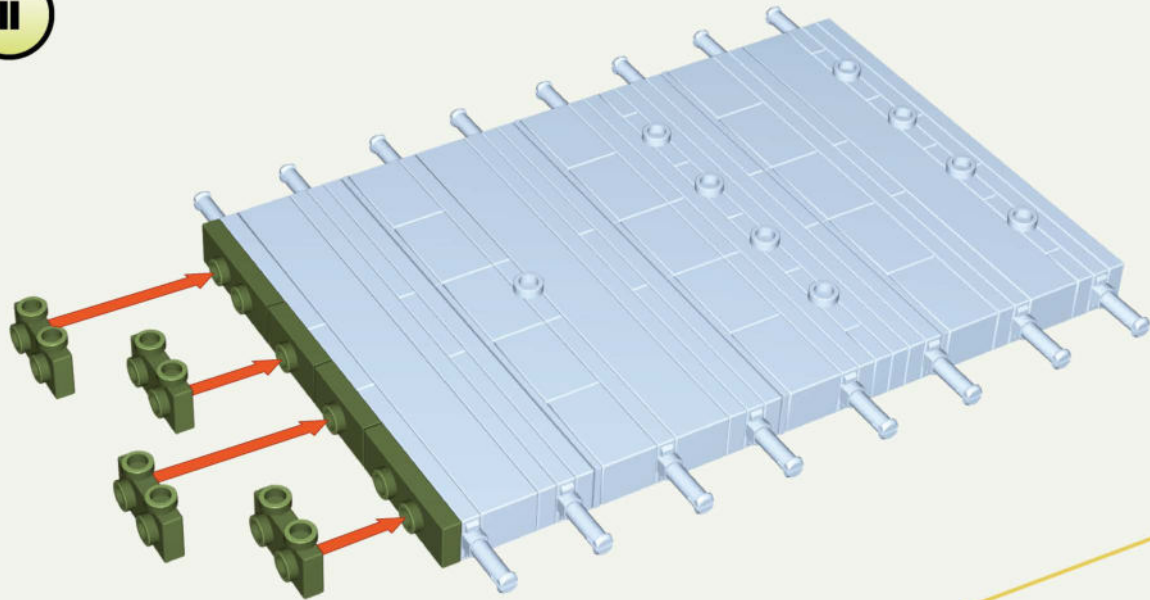

<b>x2</b>	<b>x2</b>	<b>x4</b>

12

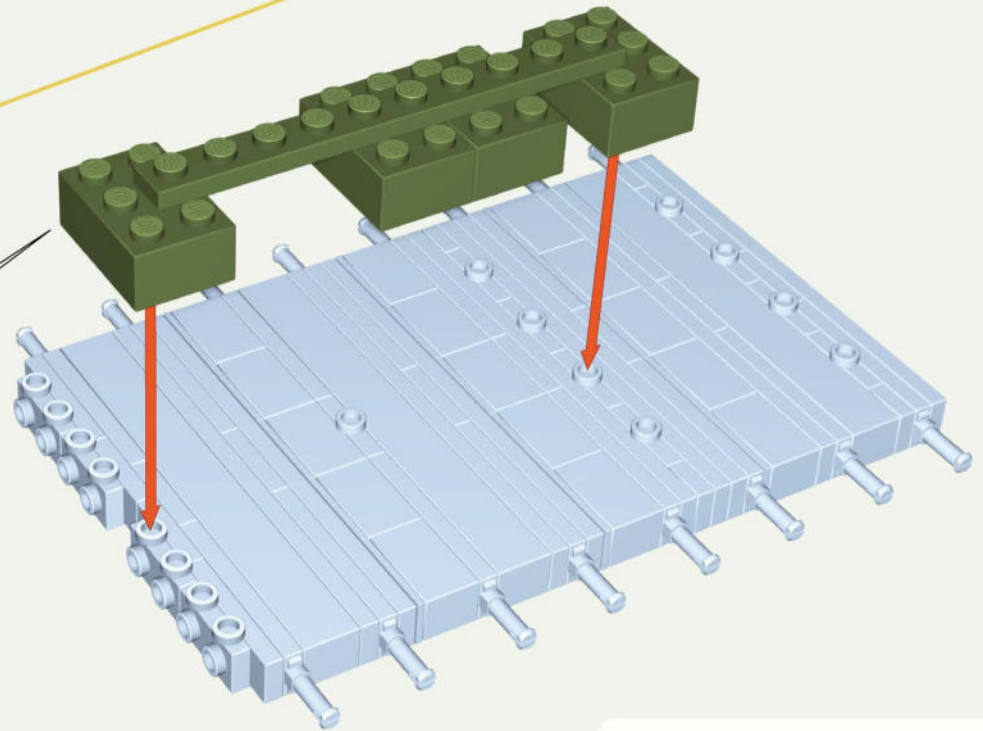
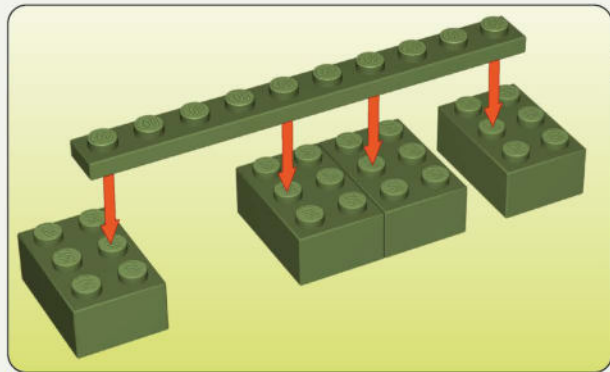

<b>x4</b>	<b>x1</b>

13

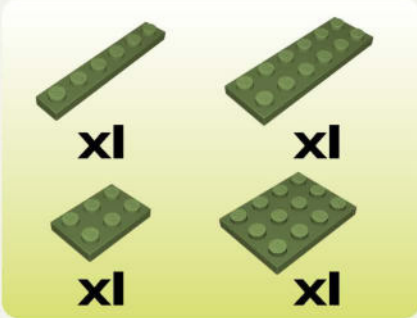
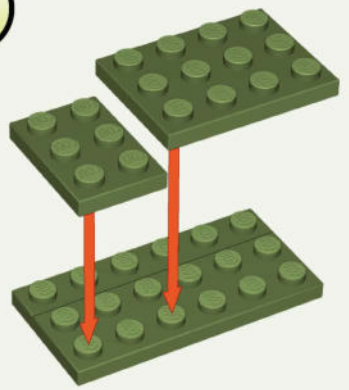

14

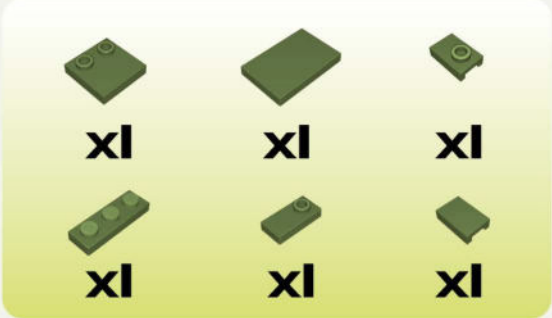
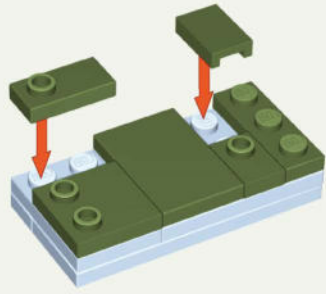

15

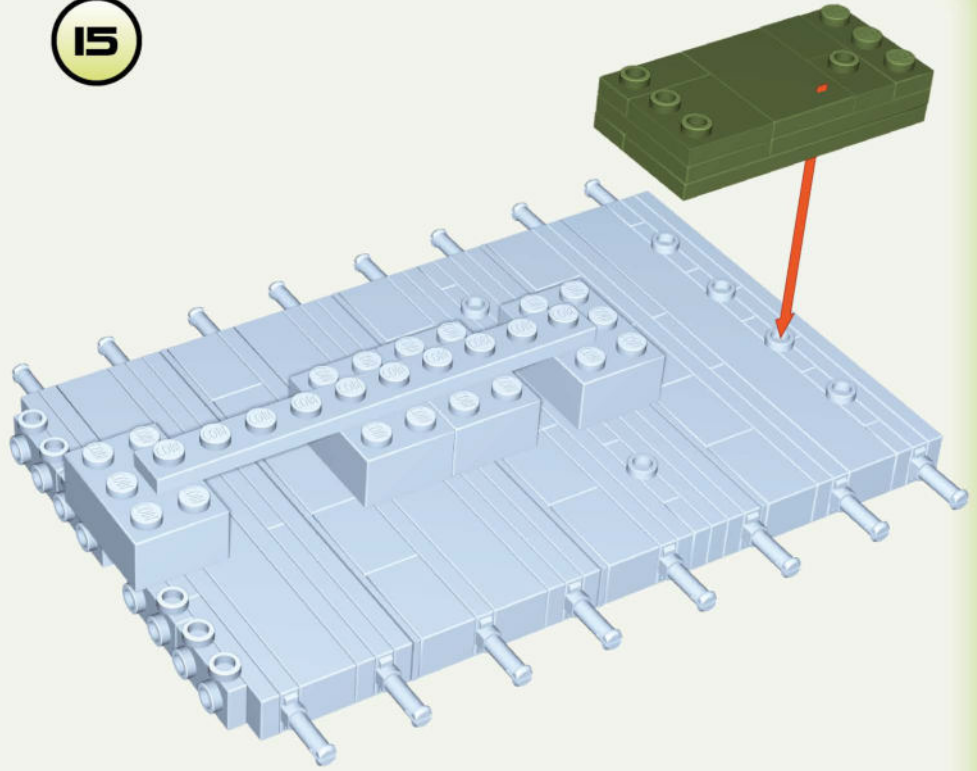

16

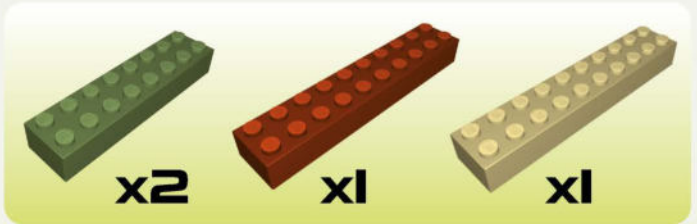
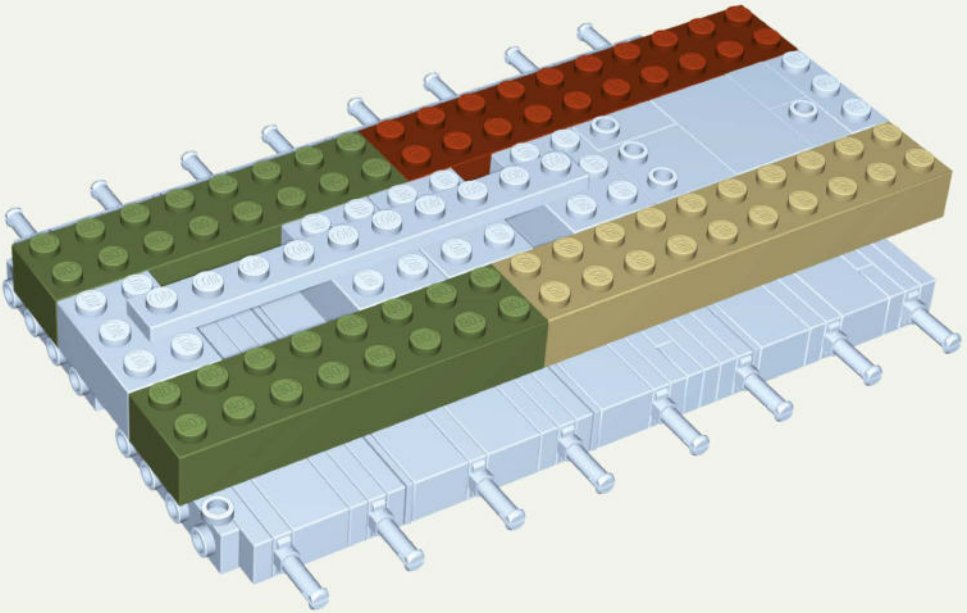



17

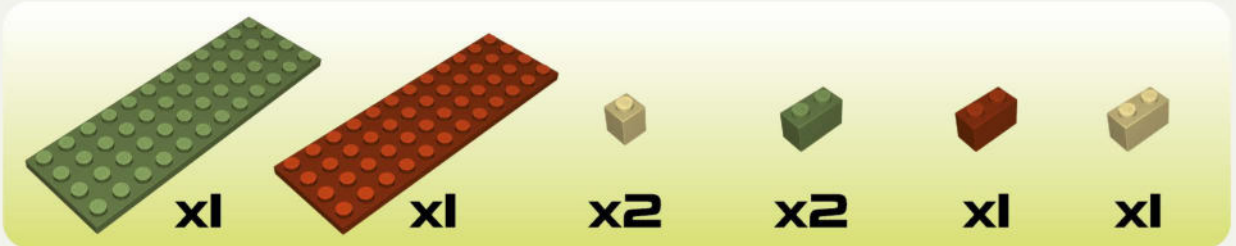
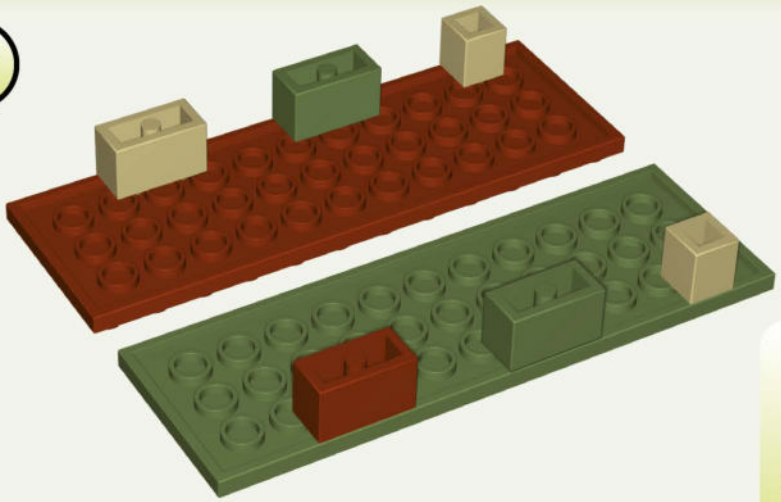

18

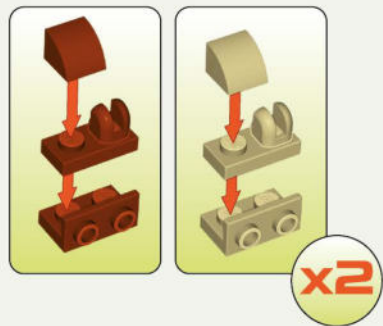
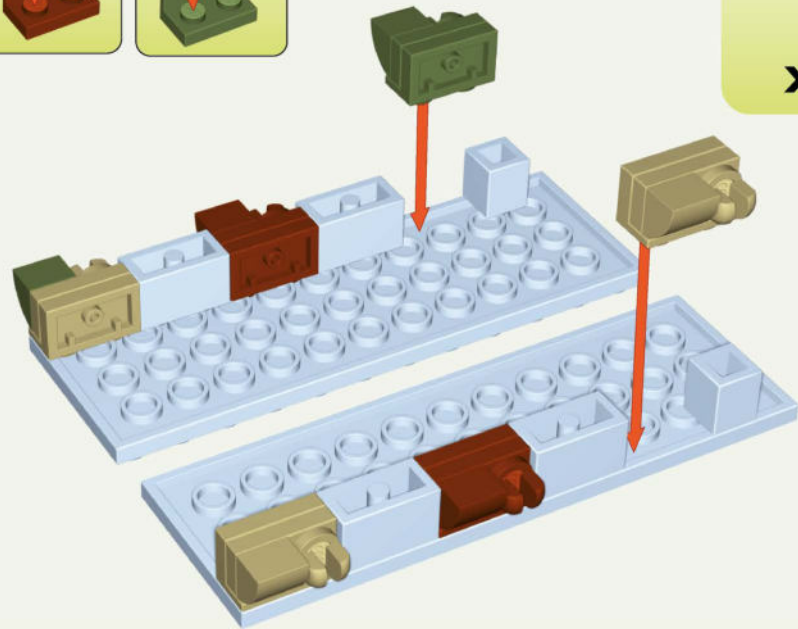
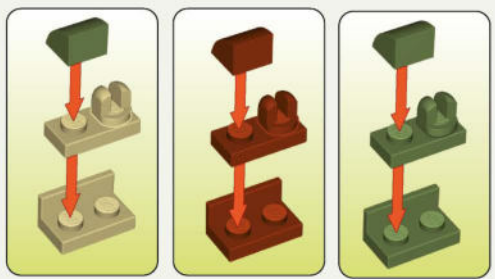

19

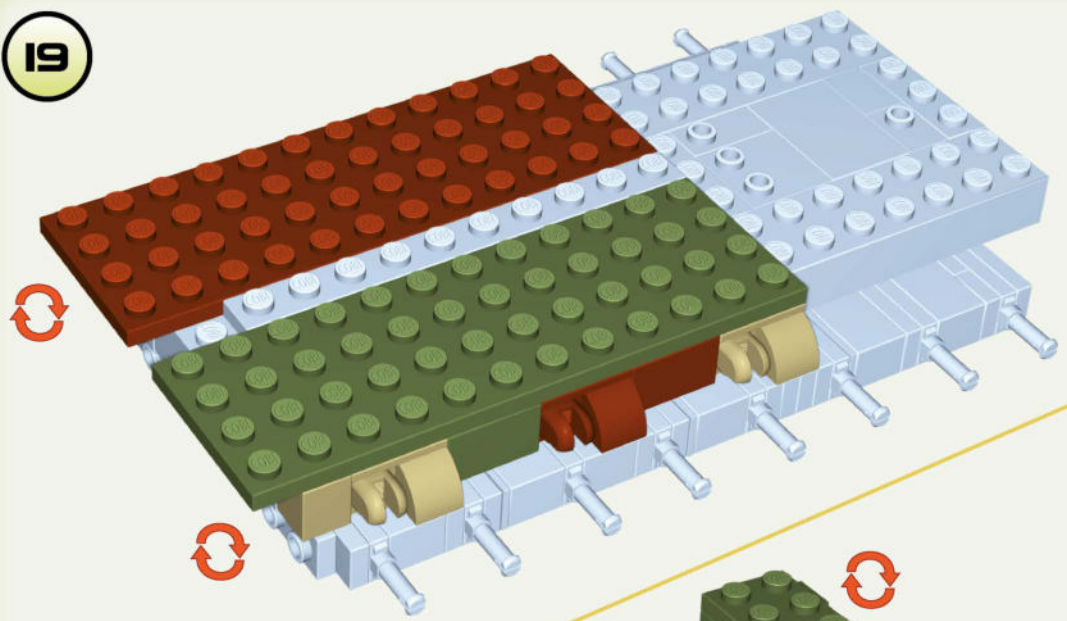

20

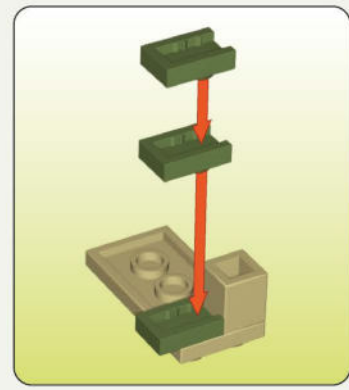
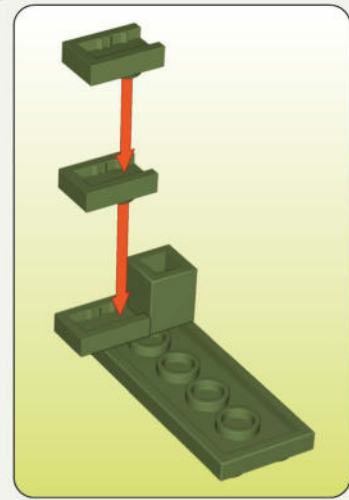
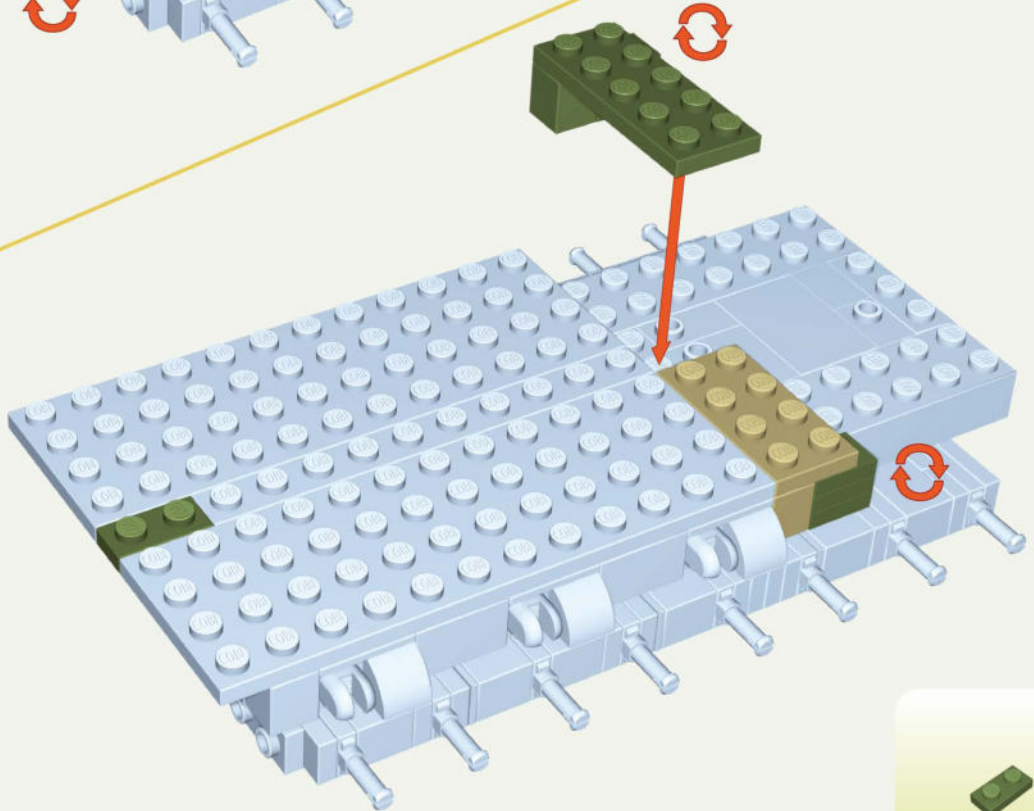

x1



x1



x1



x1



x1







x6

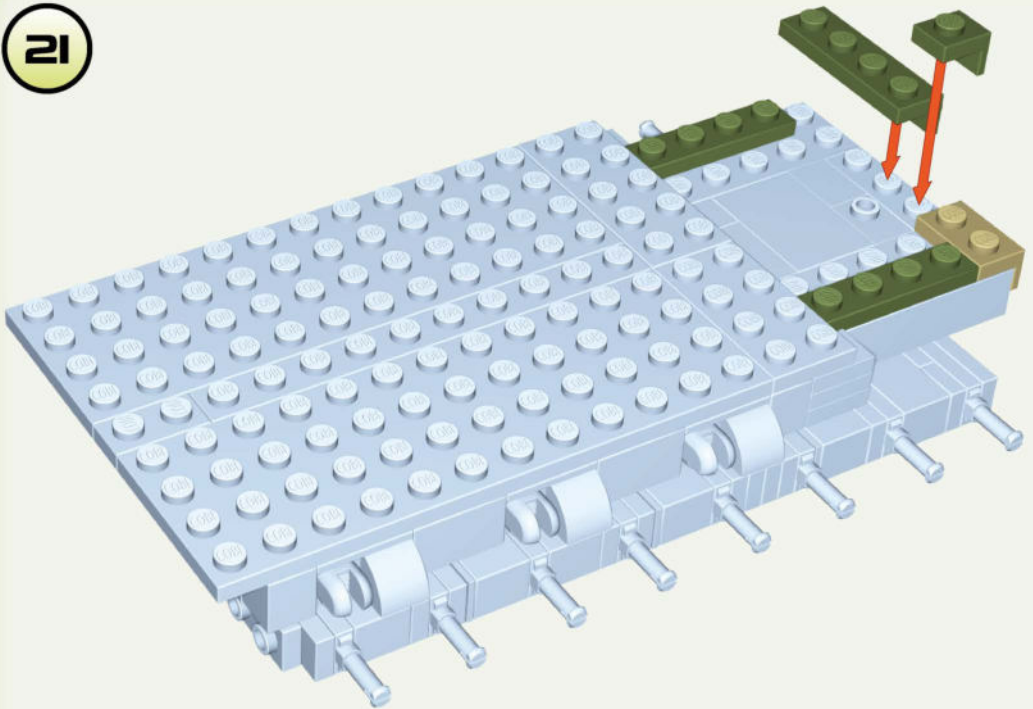





21

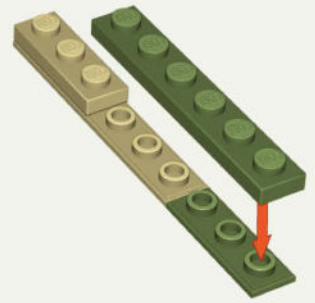

-   
**x2**
-   
**x1**
-   
**x1**
-   
**x1**



22

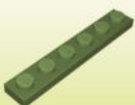

-   
**x1**
-   
**x1**
-   
**x1**
-   
**x1**

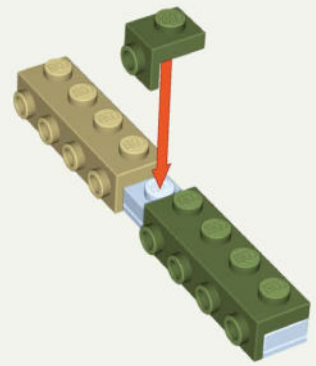

23

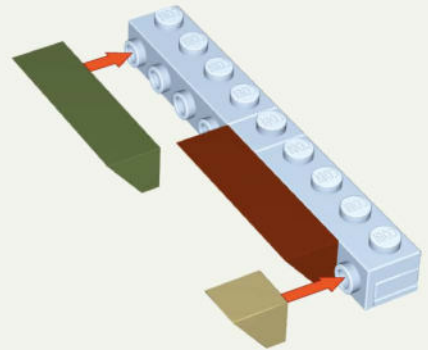

-   
**x1**
-   
**x1**
-   
**x1**

24



-   
**x1**
-   
**x1**
-   
**x1**

25

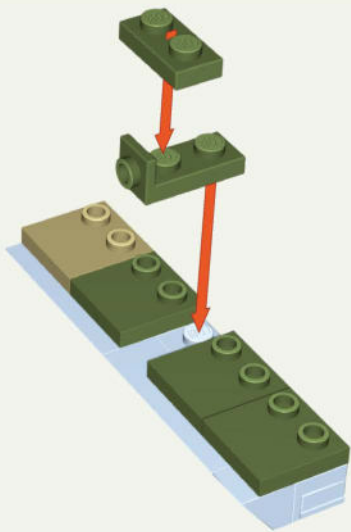

x3



x1



x1



x1

26

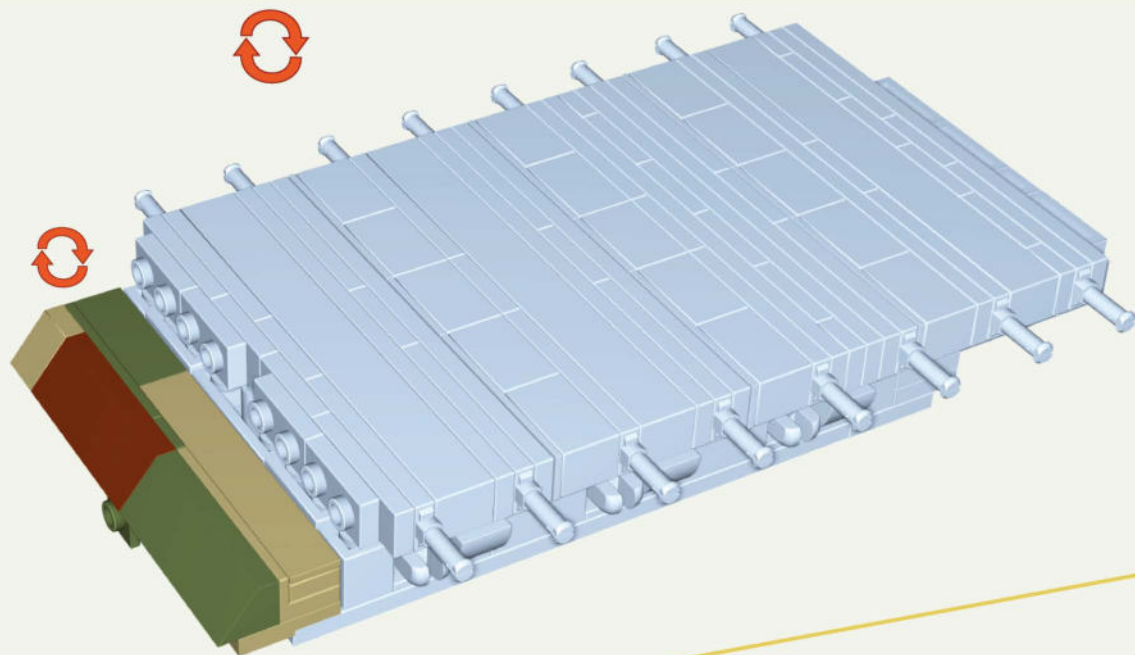

27

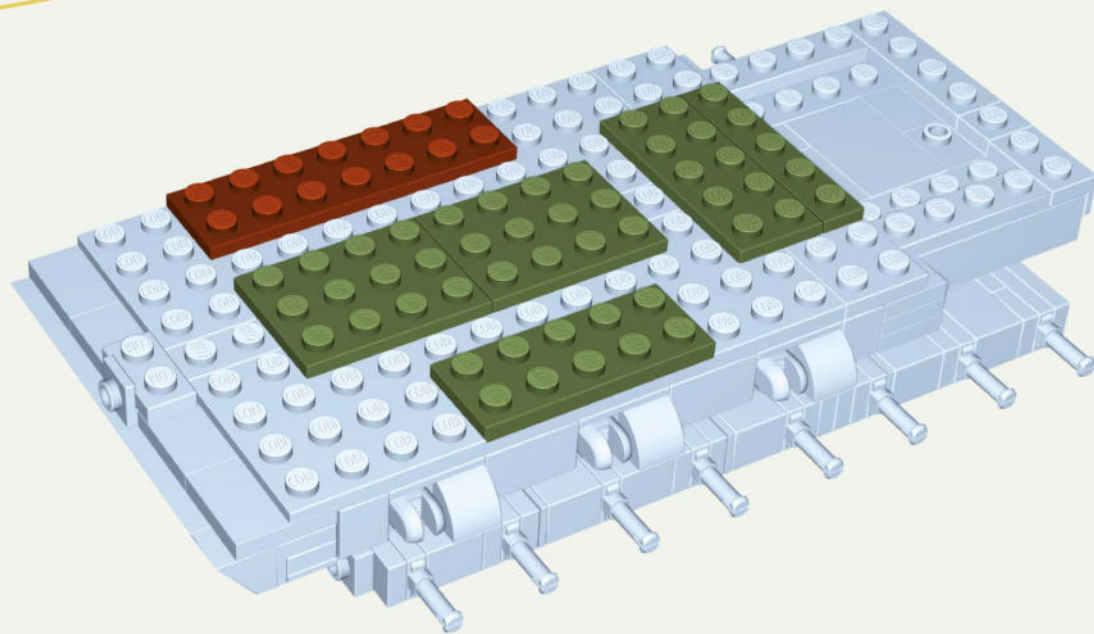

x2



x2



x1



x1



28

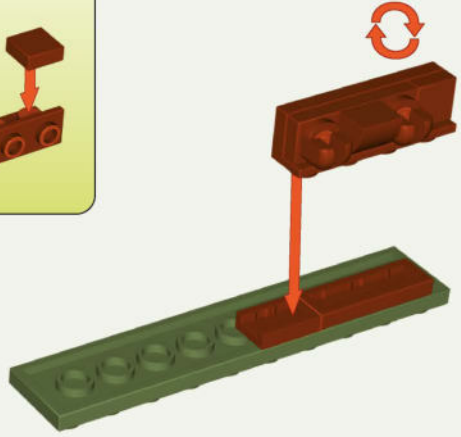
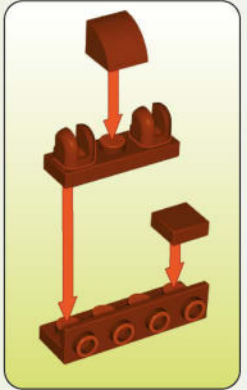

- |  |    |  |    |
|--|----|--|----|
|  | x1 |  | x1 |
|  | x1 |  | x1 |
|  | x1 |  | x1 |
|  | x2 |  | x1 |

29

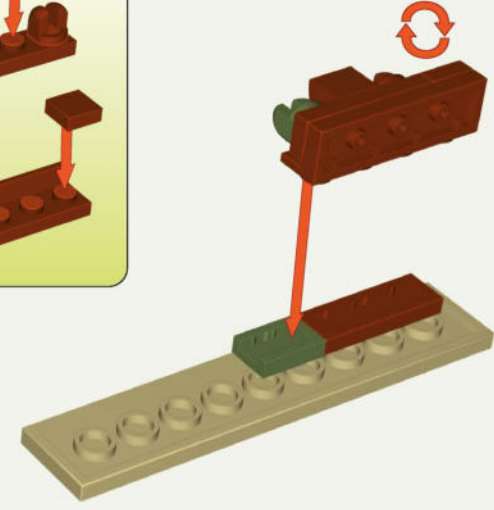
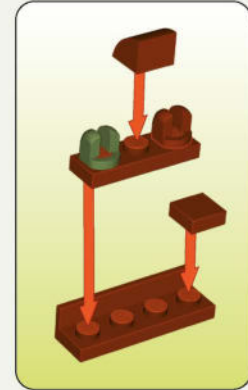

- |  |    |  |    |
|--|----|--|----|
|  | x1 |  | x1 |
|  | x1 |  | x1 |
|  | x1 |  | x1 |
|  | x1 |  | x1 |
|  |    |  | x1 |

30

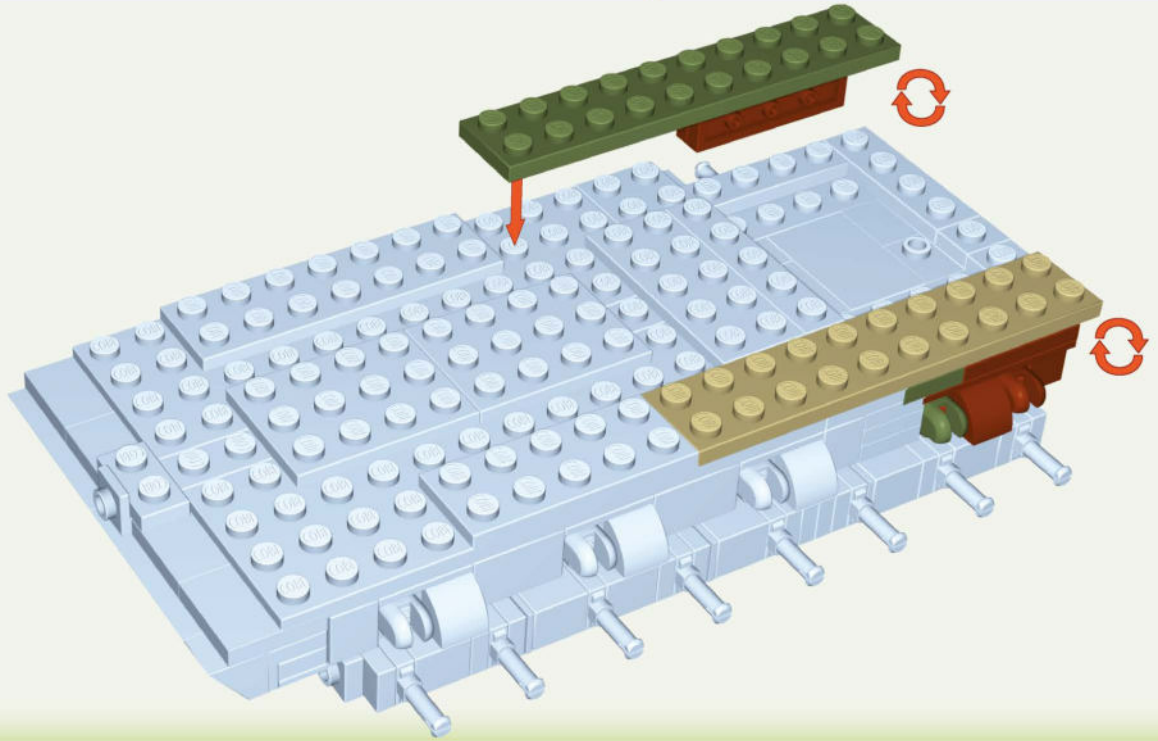

31

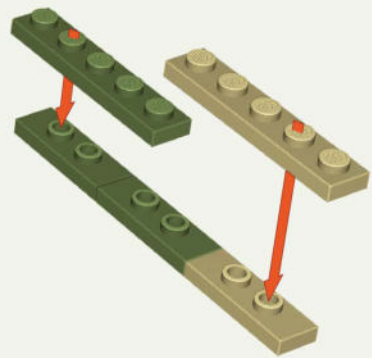

x2



x1



x1



x1

32

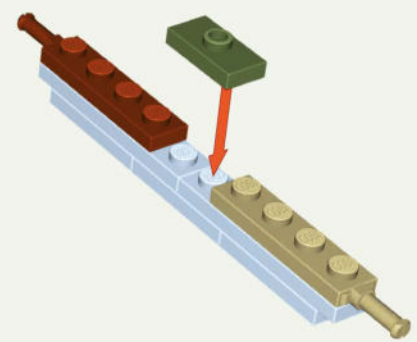

x1



x1



x1

33

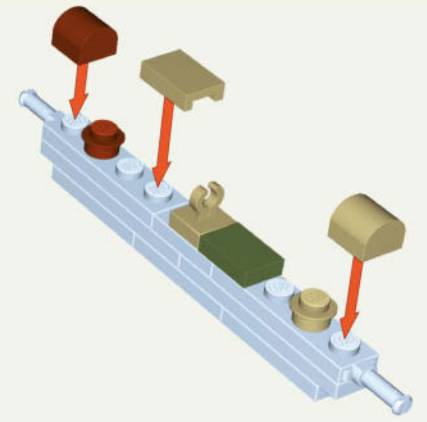

x1



x1



x1



x1



x1



x1



x1

34

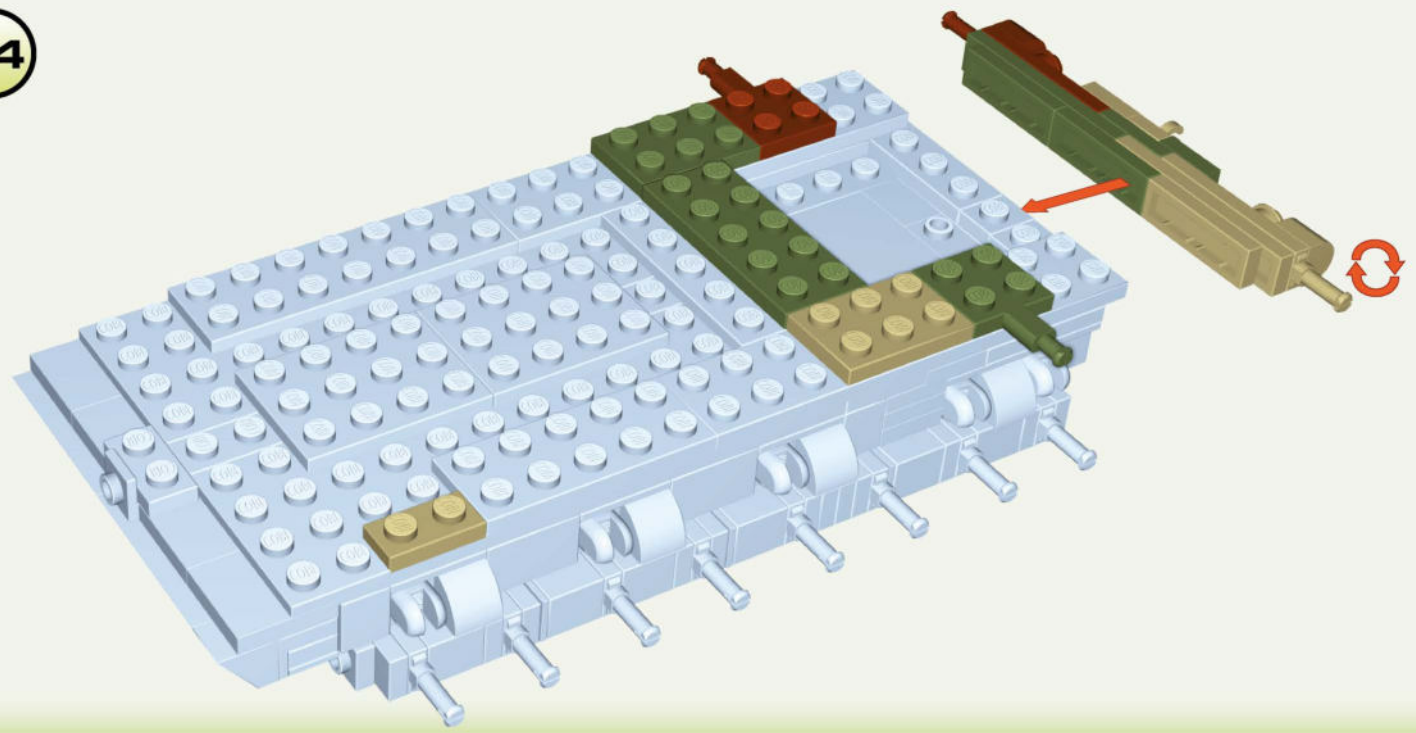

x1



x1



x1



x1



x1







x1

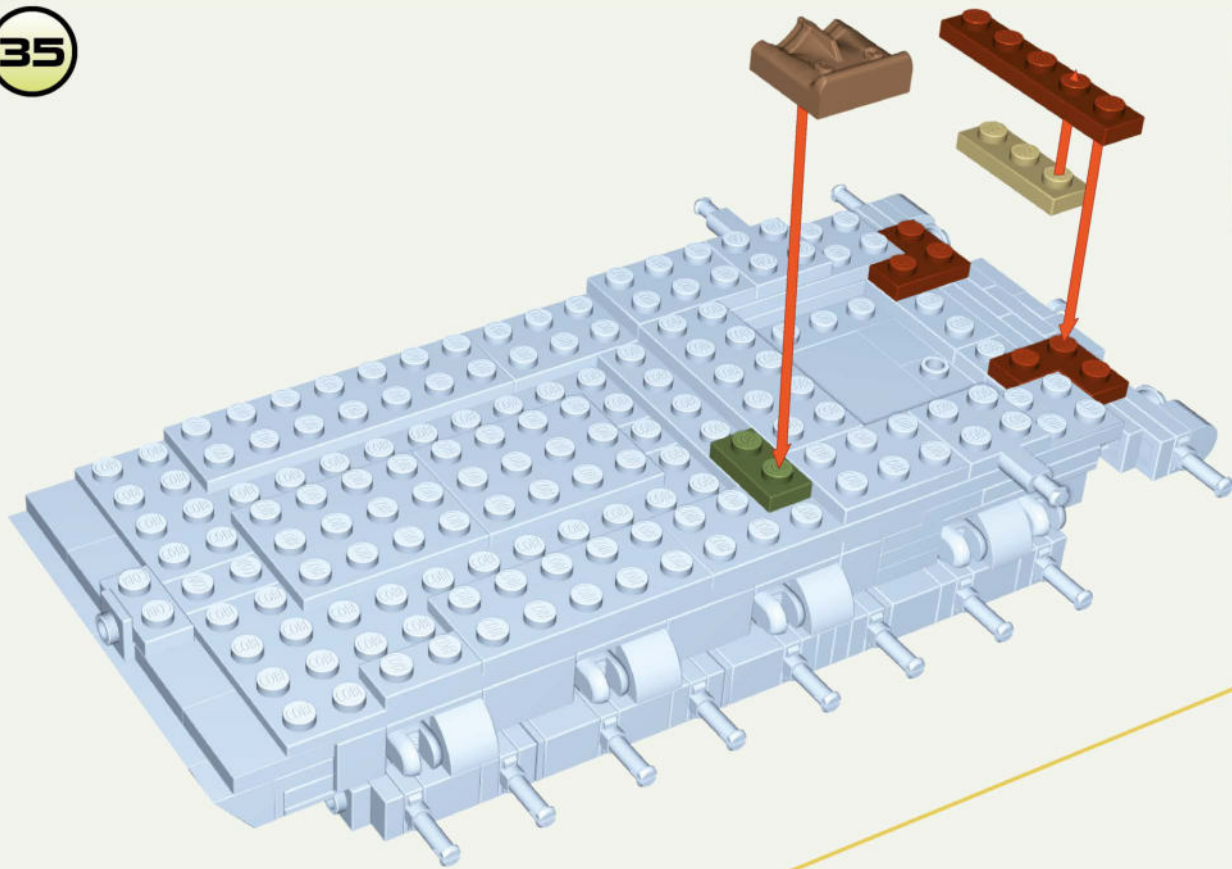





35



				
<b>x2</b>	<b>x1</b>	<b>x1</b>	<b>x1</b>	<b>x1</b>



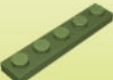

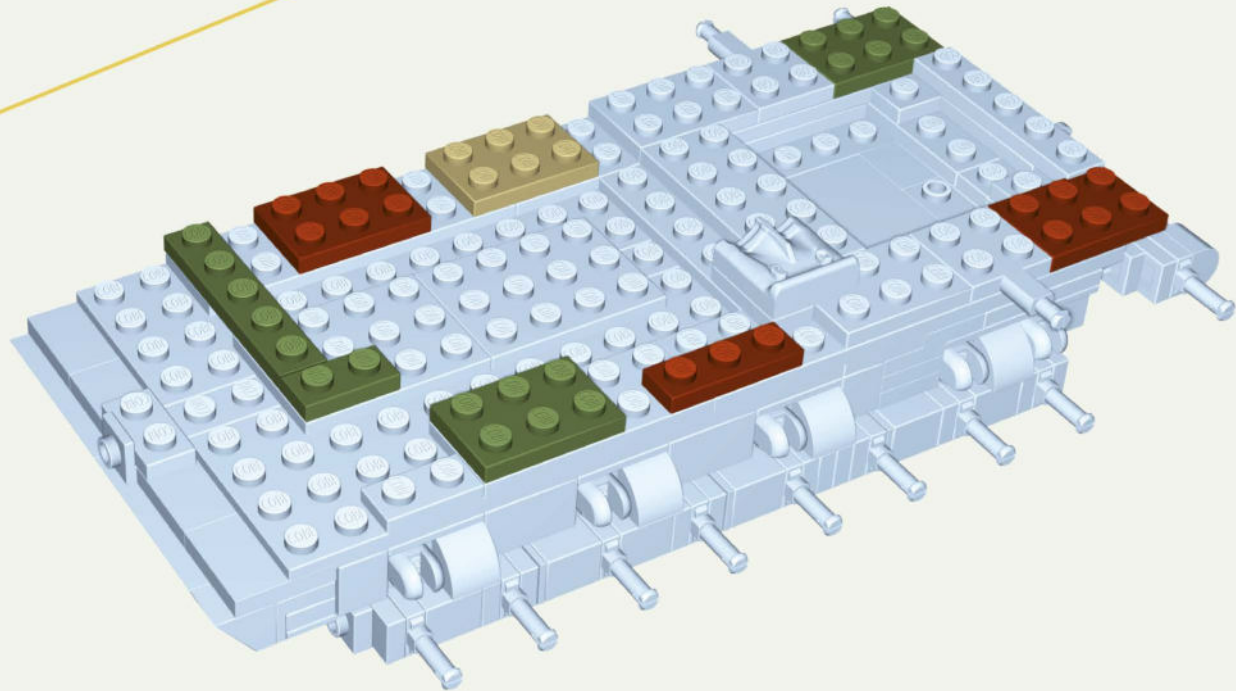

36

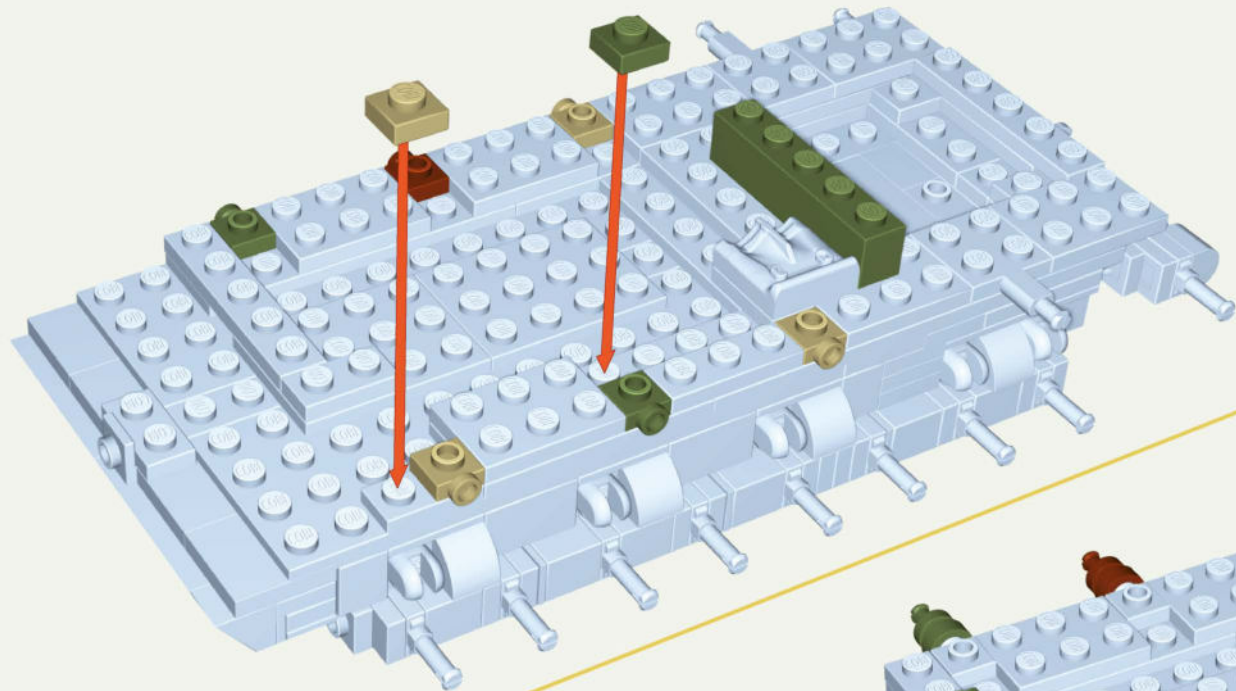
		
<b>x2</b>	<b>x1</b>	<b>x2</b>
		
<b>x1</b>	<b>x1</b>	<b>x1</b>









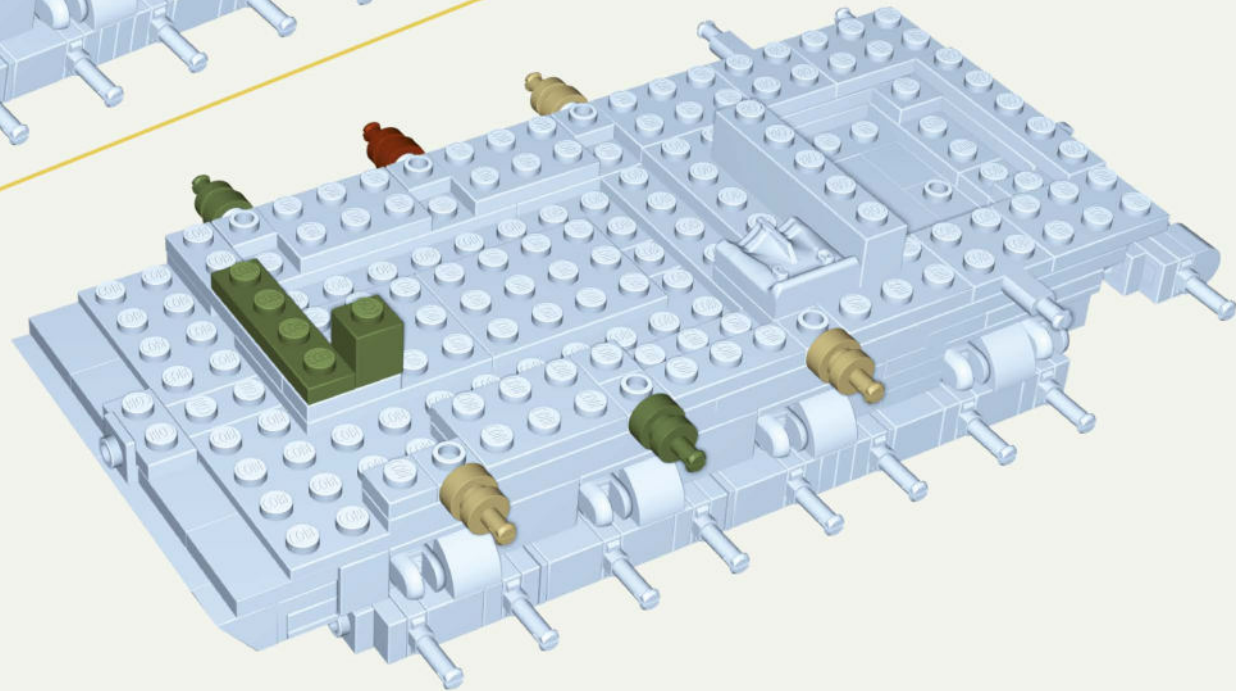

37





-  x3
-  x2
-  x1
-  x1
-  x1
-  x1

38







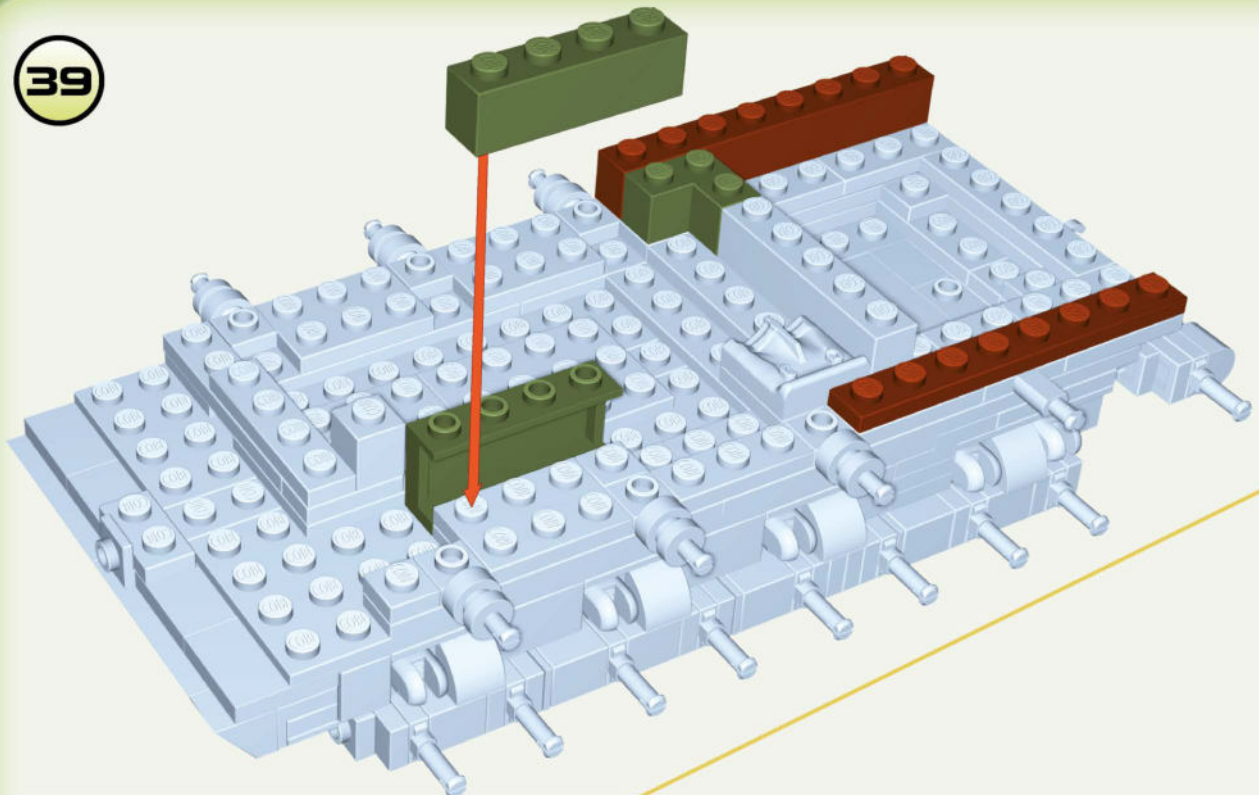

-  x1
-  x1
-  x2
-  x2
-  x3
-  x3
-  x1
-  x1

-  x2
-  x3
- 



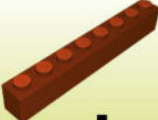





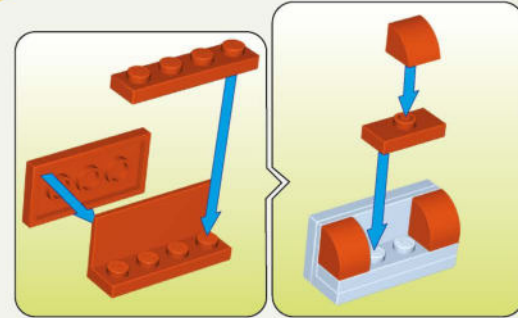

39



-  **x1**
-  **x1**
-  **x1**
-  **x1**
-  **x1**



40

-  **x1**
-  **x1**
-  **x1**
-  **x1**
-  **x2**
-  **x1**
-  **x1**
-  **x1**
-  **x1**

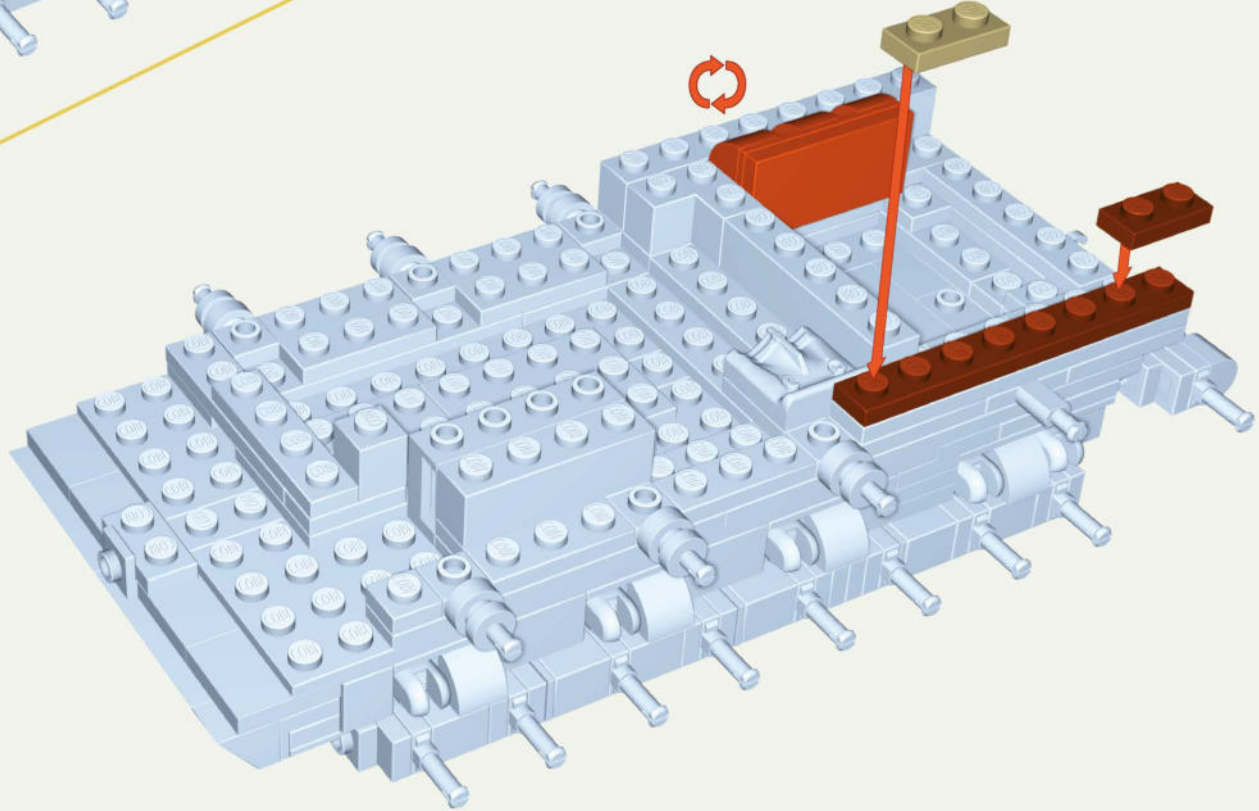





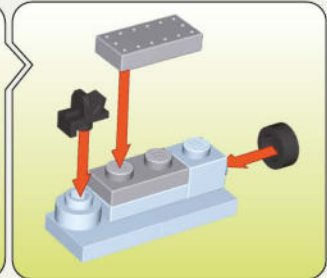
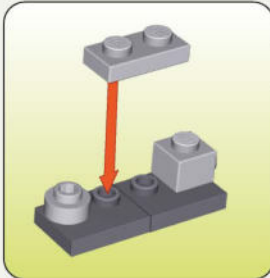
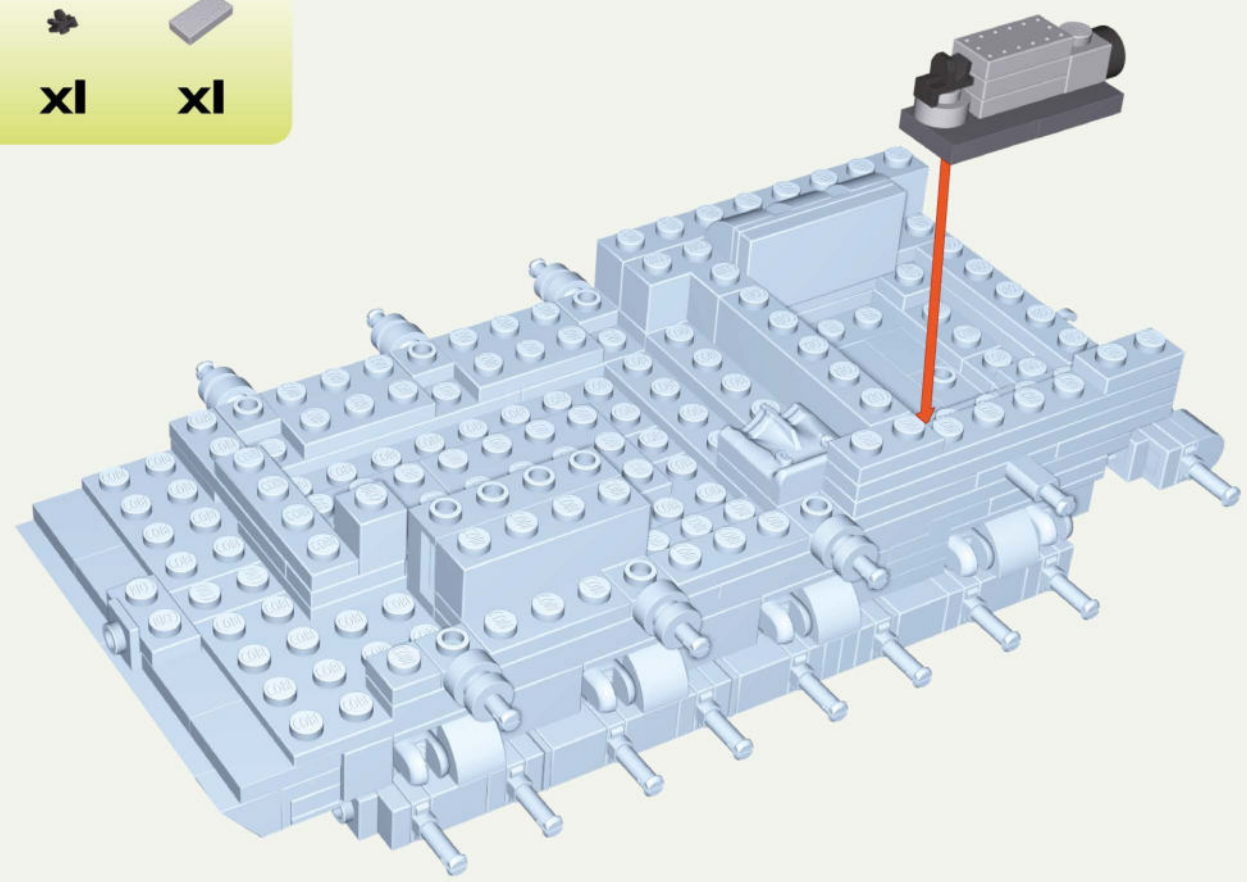
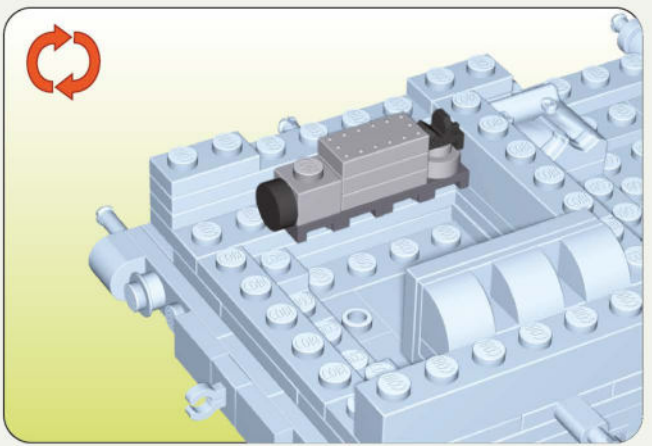

41

-   
**x2**
-   
**x1**
-   
**x1**
-   
**x2**
-   
**x1**
-   
**x1**
-   
**x1**

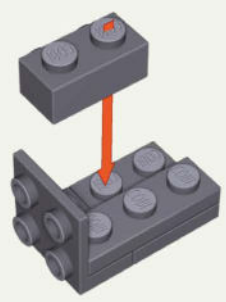





42

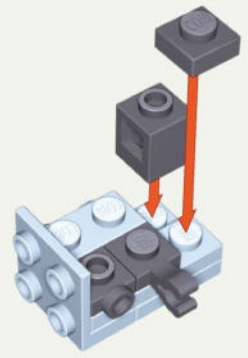

-   
**x1**
-   
**x1**
-   
**x1**
-   
**x1**

43



-   
**x1**
-   
**x1**
-   
**x1**
-   
**x1**



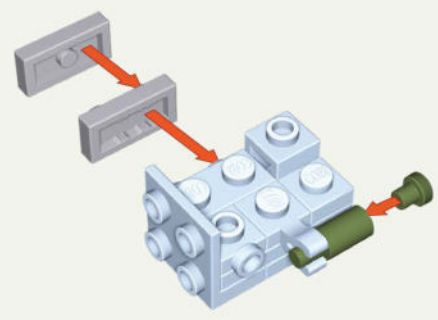

44

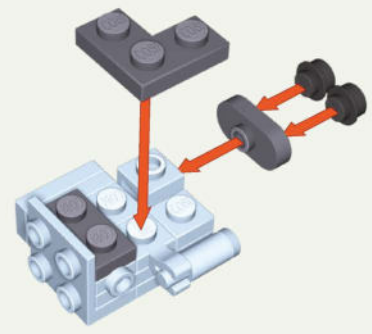

	
<b>x1</b>	<b>x1</b>
	
<b>x1</b>	<b>x1</b>



45



	
<b>x1</b>	<b>x1</b>
	
<b>x1</b>	<b>x2</b>

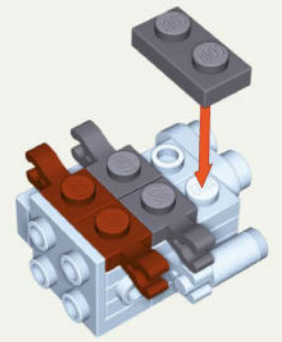

46



	
<b>x2</b>	<b>x2</b>
	
	<b>x1</b>

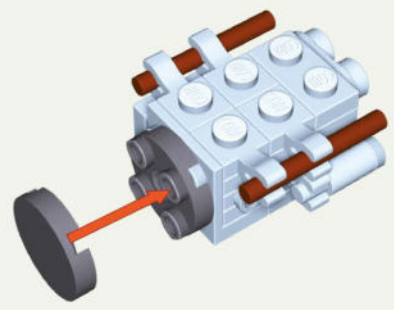

47



	
<b>x2</b>	<b>x1</b>
	
	<b>x1</b>

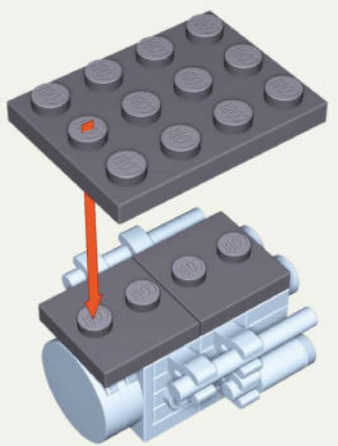



48

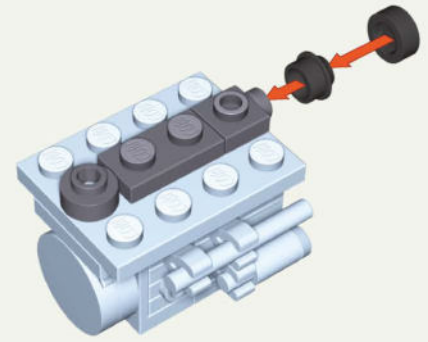

	
<b>x2</b>	<b>x1</b>





49

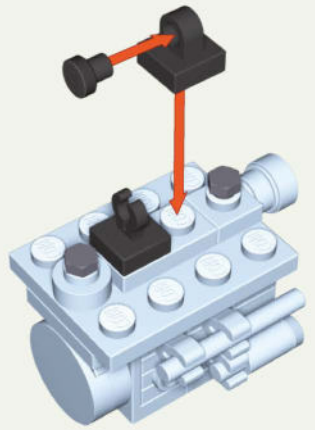

		
<b>x1</b>	<b>x1</b>	<b>x1</b>
		
	<b>x1</b>	<b>x1</b>







50

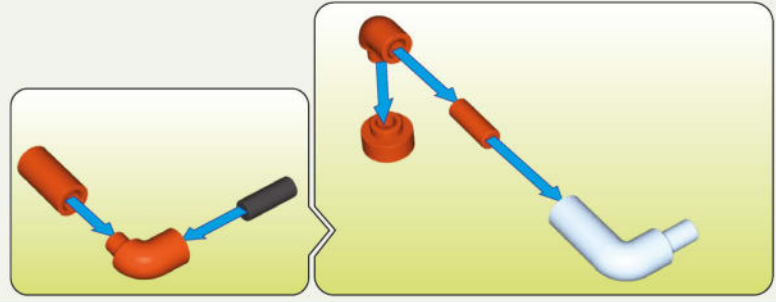
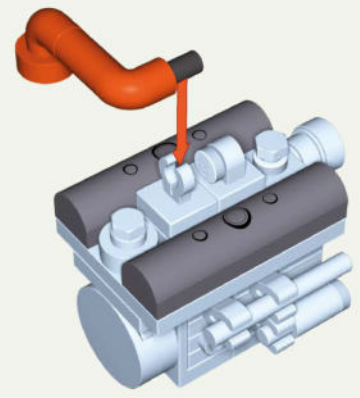

-  x1
-  x1
-  x2
-  x1





51

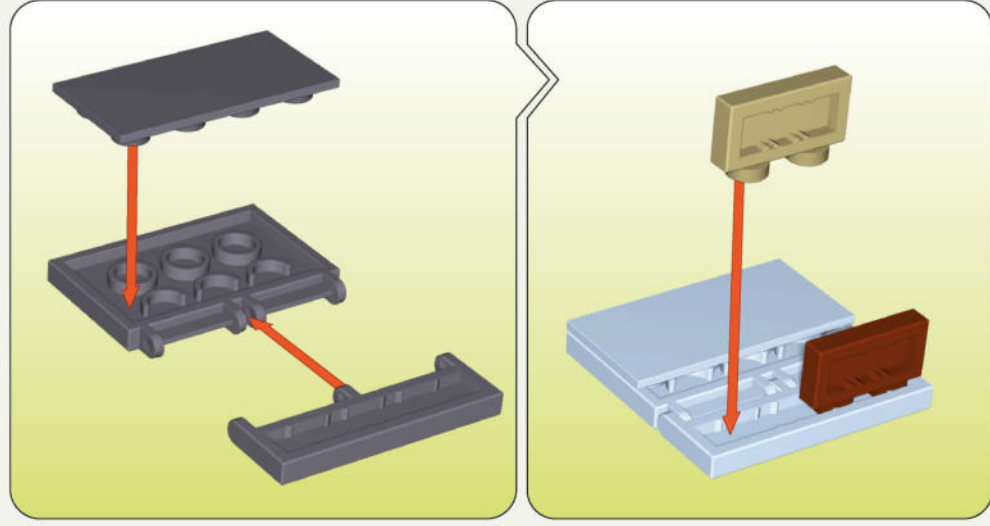

-  x2
-  x2
-  x1
-  x1
-  x1
-  x1

52



-  x1
-  x1
-  x1
-  x1
-  x1



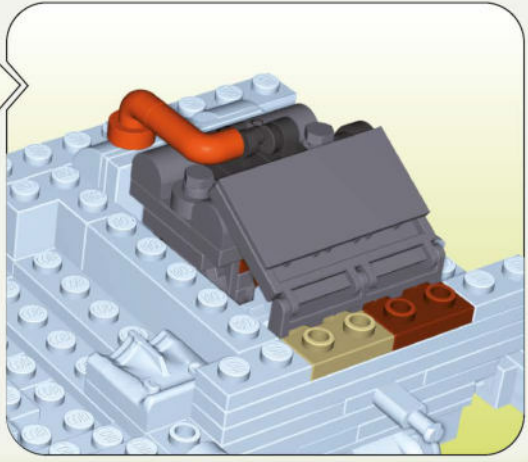
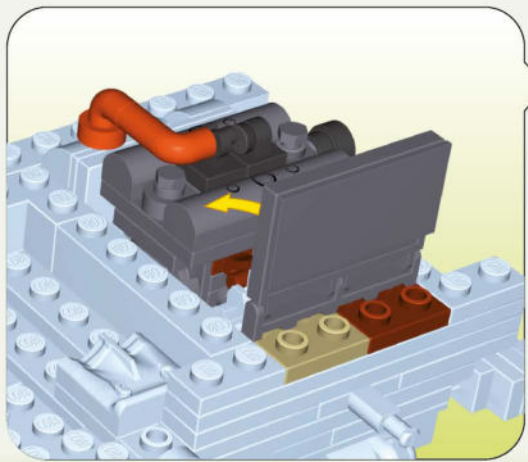
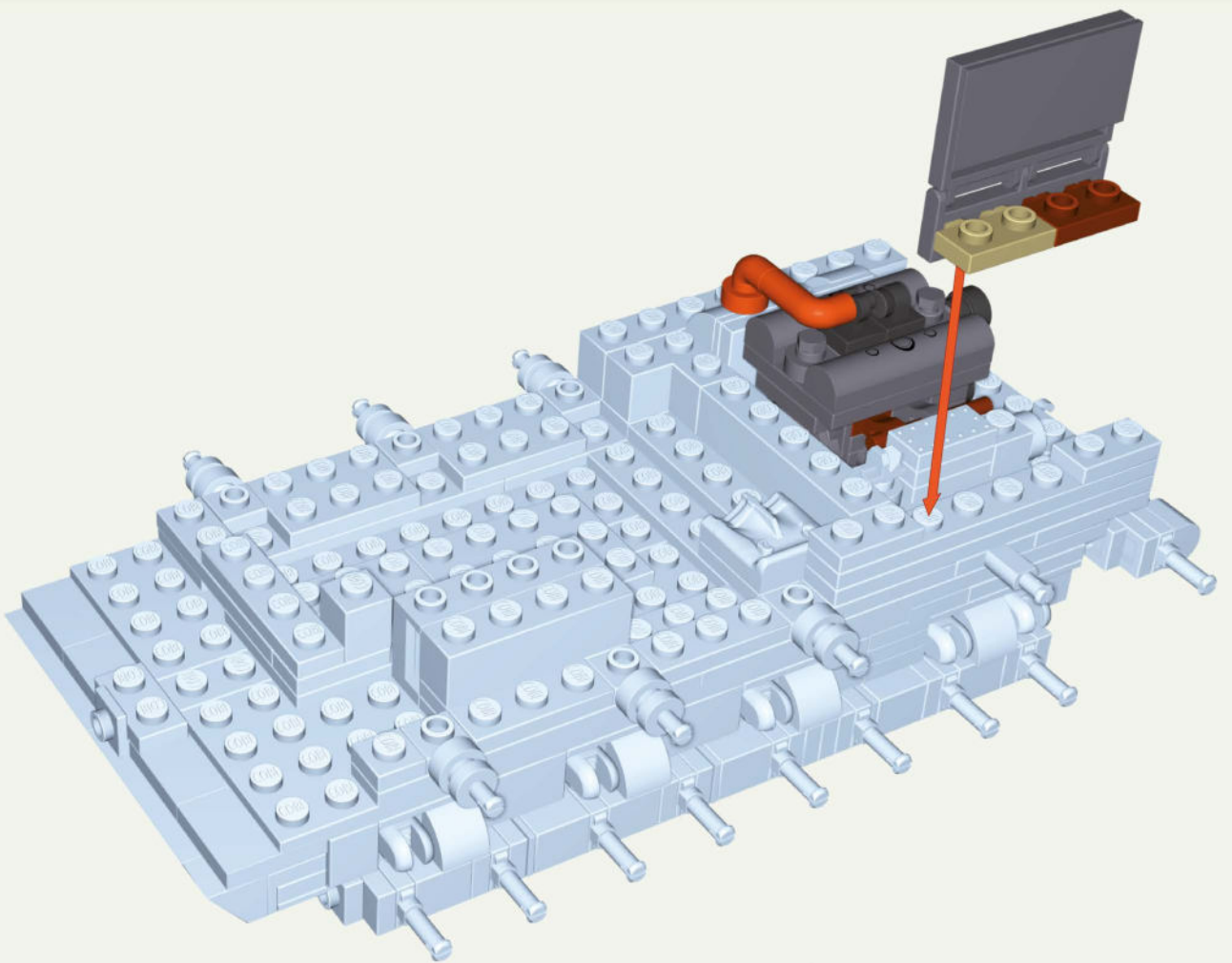
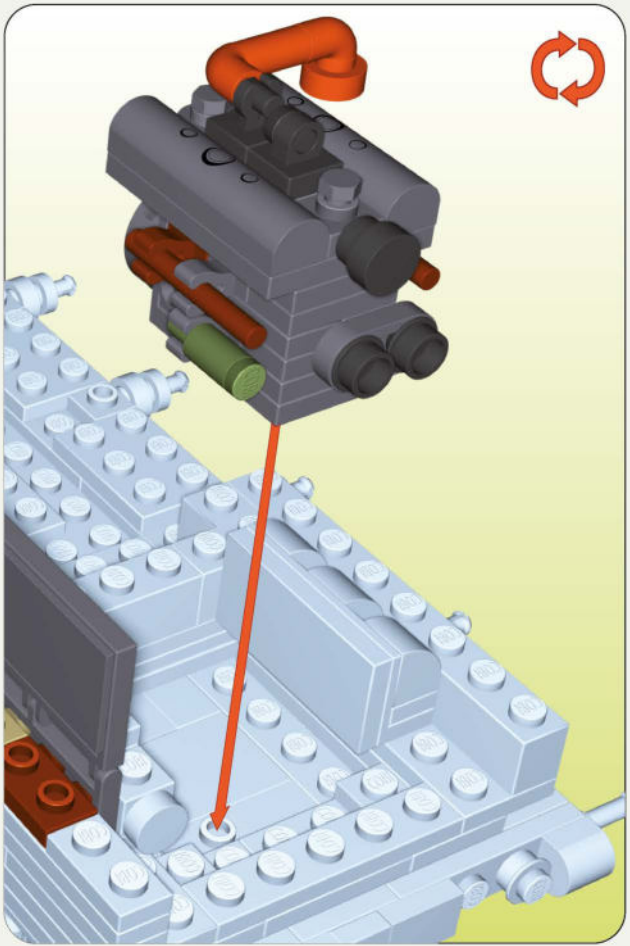



54

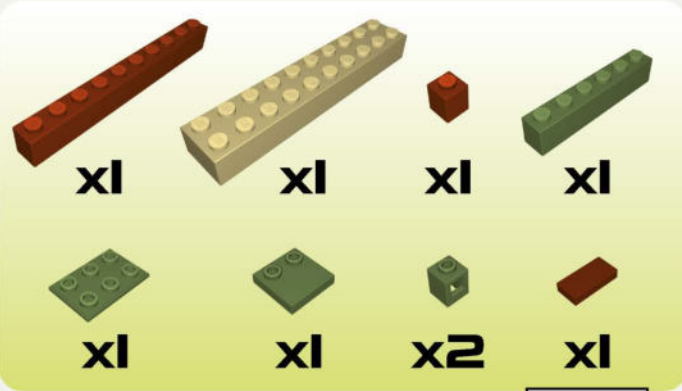
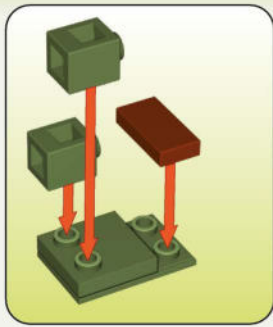

1:1

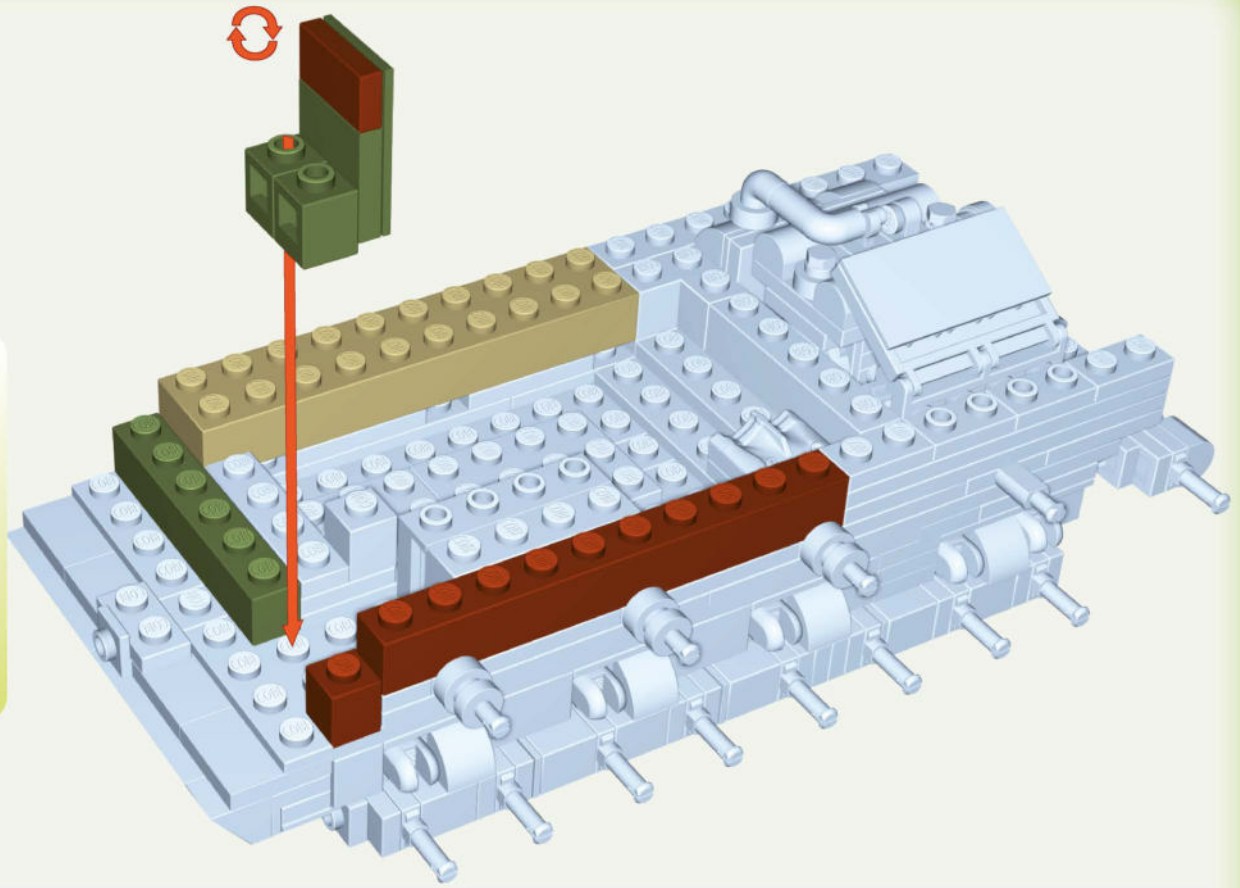

55

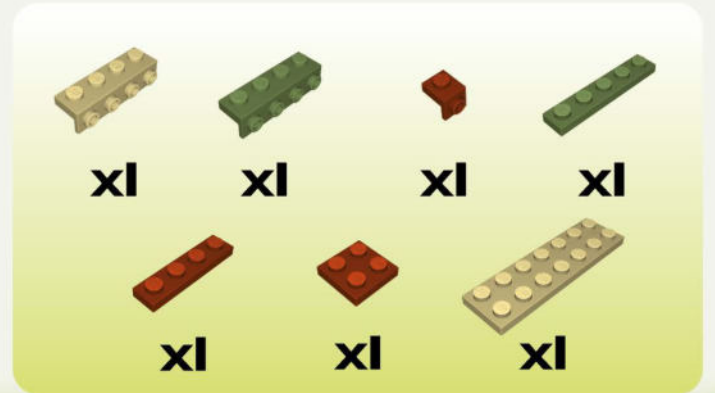
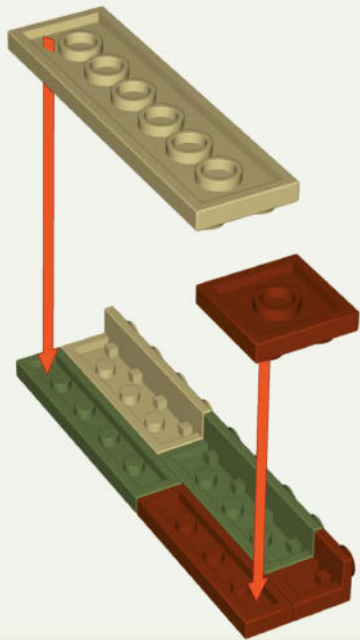

56

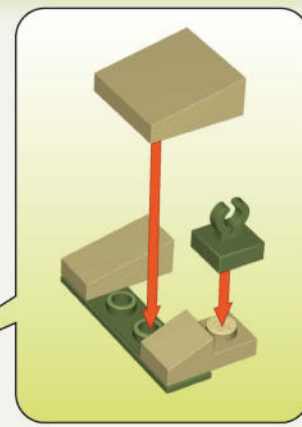
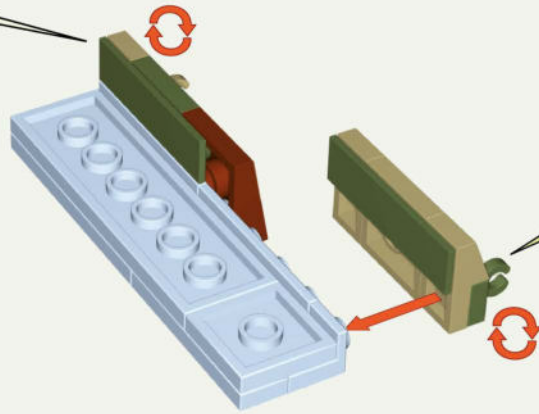
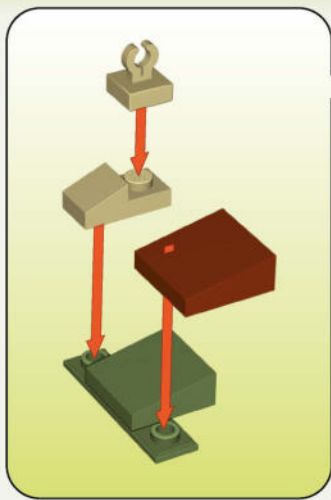

- |           |           |           |           |
|-----------|-----------|-----------|-----------|
|           |           |           |           |
| <b>x2</b> | <b>x1</b> | <b>x2</b> | <b>x1</b> |
|           |           |           |           |
| <b>x1</b> | <b>x1</b> | <b>x1</b> | <b>x1</b> |

57

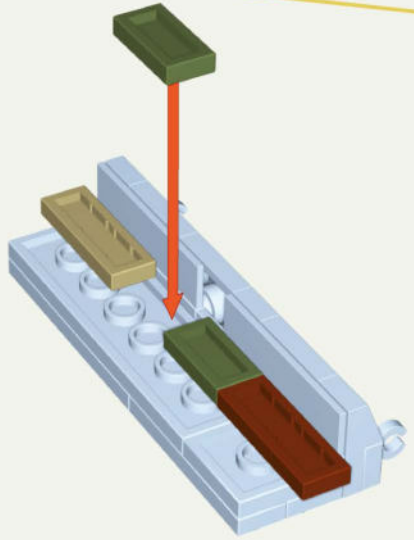

- |           |           |           |
|-----------|-----------|-----------|
|           |           |           |
| <b>x1</b> | <b>x1</b> | <b>x2</b> |

58

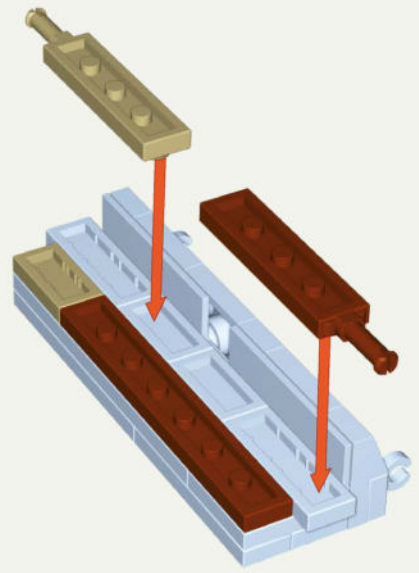

- |           |           |           |           |
|-----------|-----------|-----------|-----------|
|           |           |           |           |
| <b>x1</b> | <b>x1</b> | <b>x1</b> | <b>x1</b> |



59

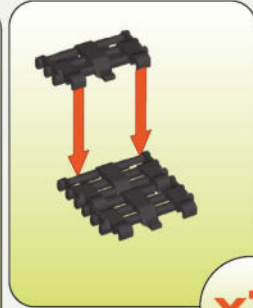
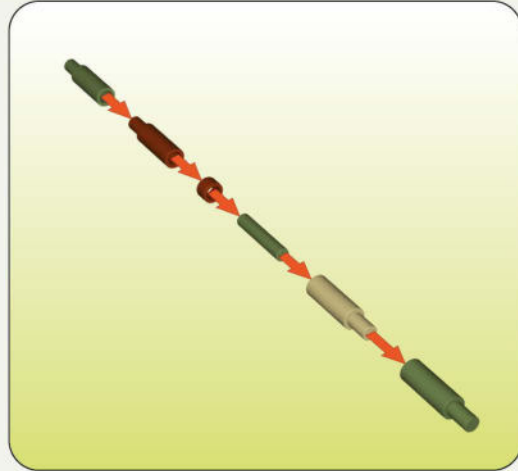
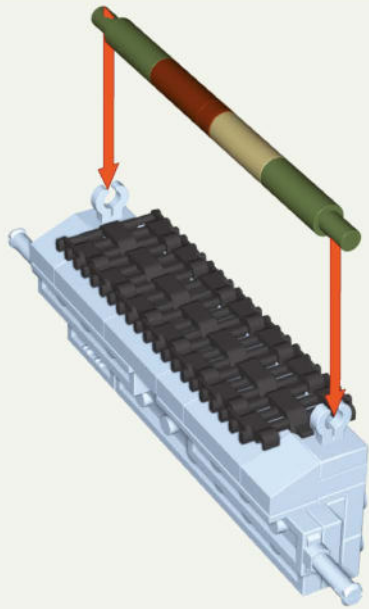

x7

- |    |    |    |
|----|----|----|
|    |    |    |
| x7 | x2 | x1 |
|    |    |    |
| x1 | x1 | x1 |

60

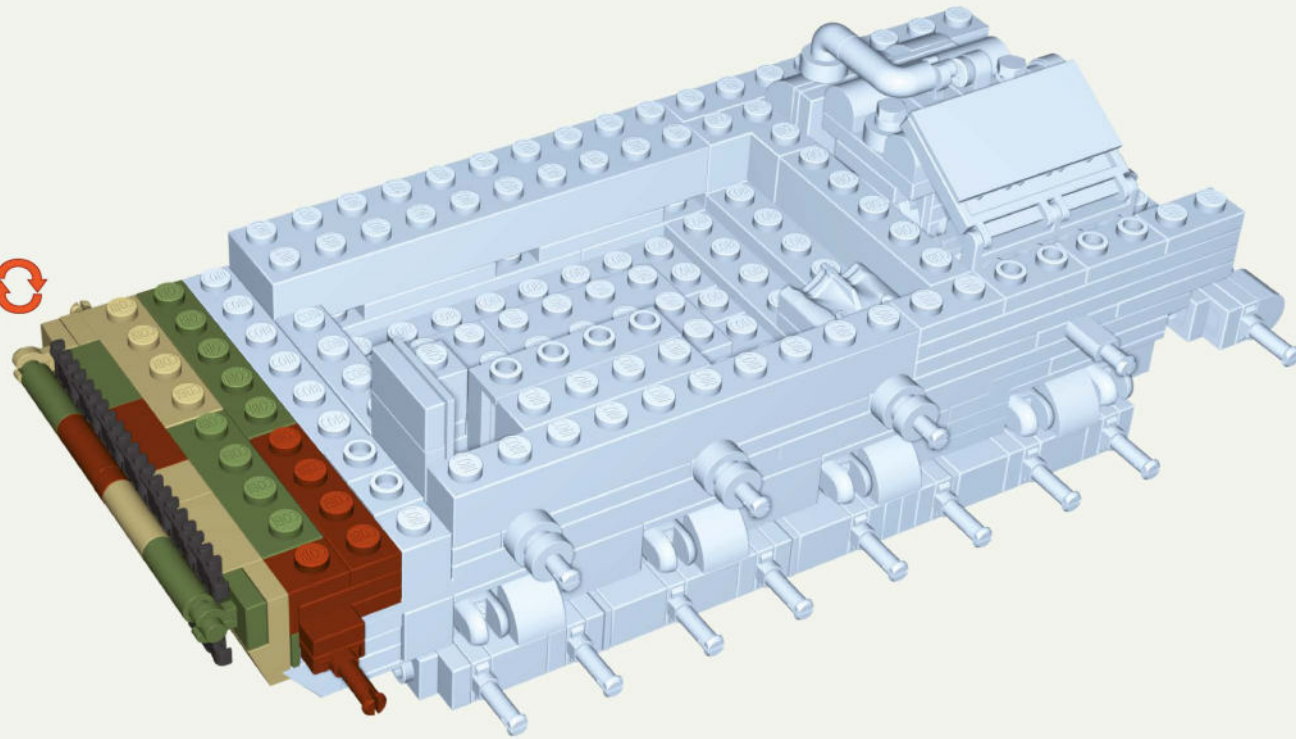

61



x1



x1



x1



x1



x1



x2



x1

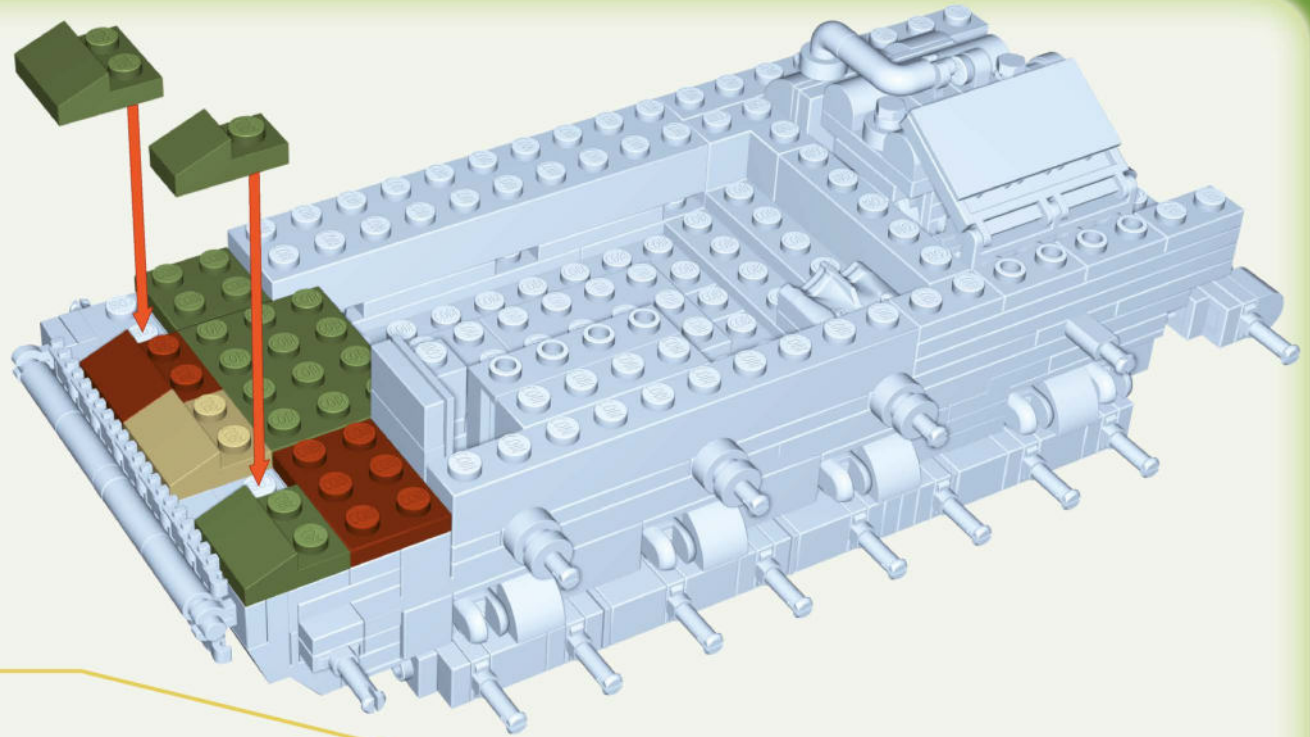

62

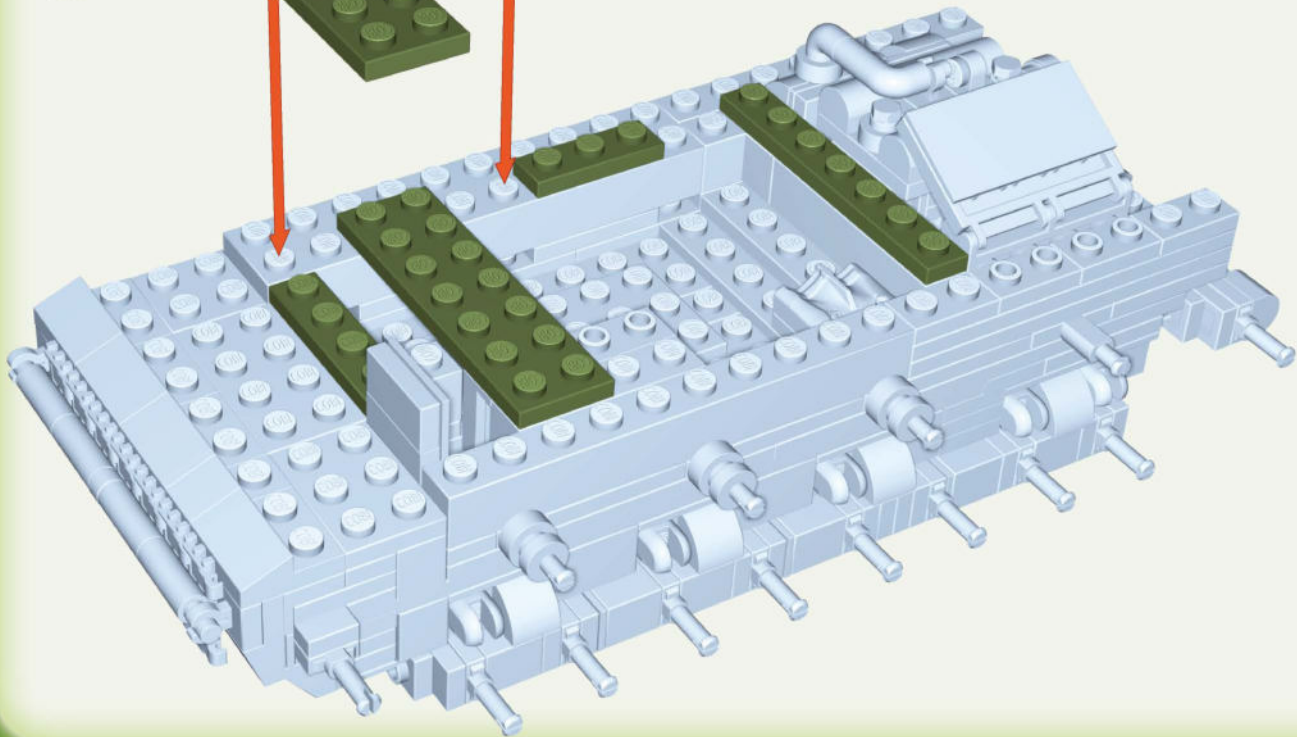

x1



x1



x1



x1



x1





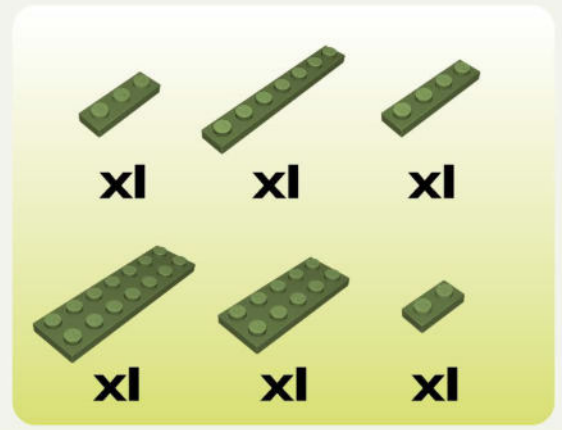

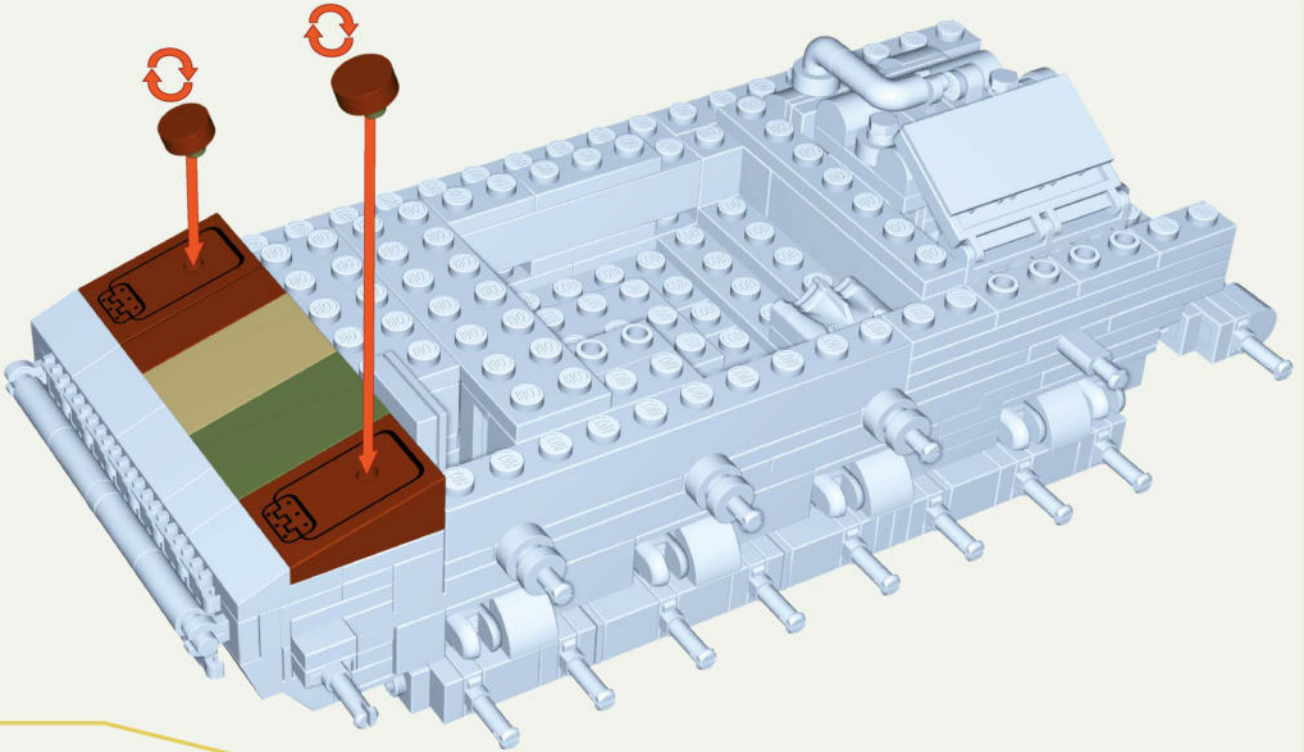
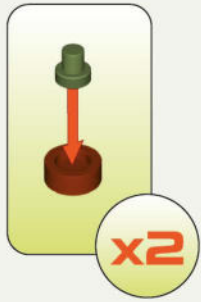

x1

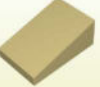







63

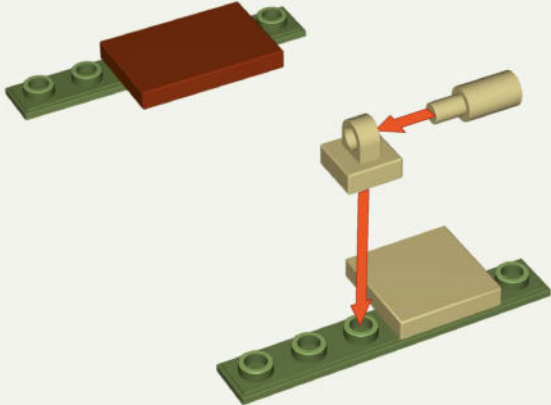

		
<b>x1</b>	<b>x1</b>	<b>x1</b>
		
<b>x2</b>	<b>x2</b>	<b>x2</b>

64









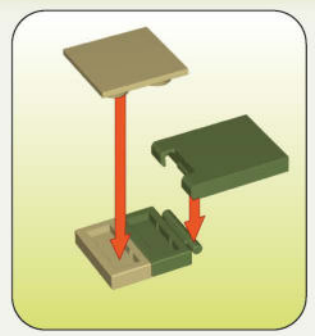
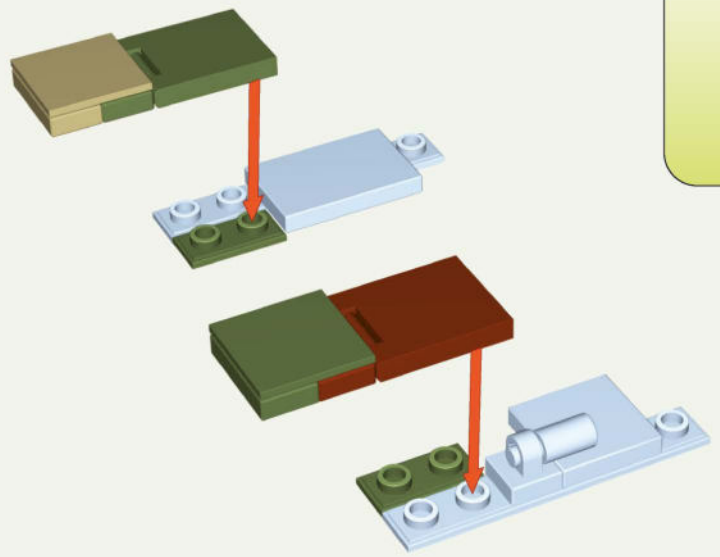

				
<b>x2</b>	<b>x1</b>	<b>x1</b>	<b>x1</b>	<b>x1</b>



65



1:1

-   
**x2**
-   
**x1**
-   
**x1**
-   
**x1**
-   
**x1**
-   
**x1**
-   
**x1**
-   
**x1**
-   
**x1**

66

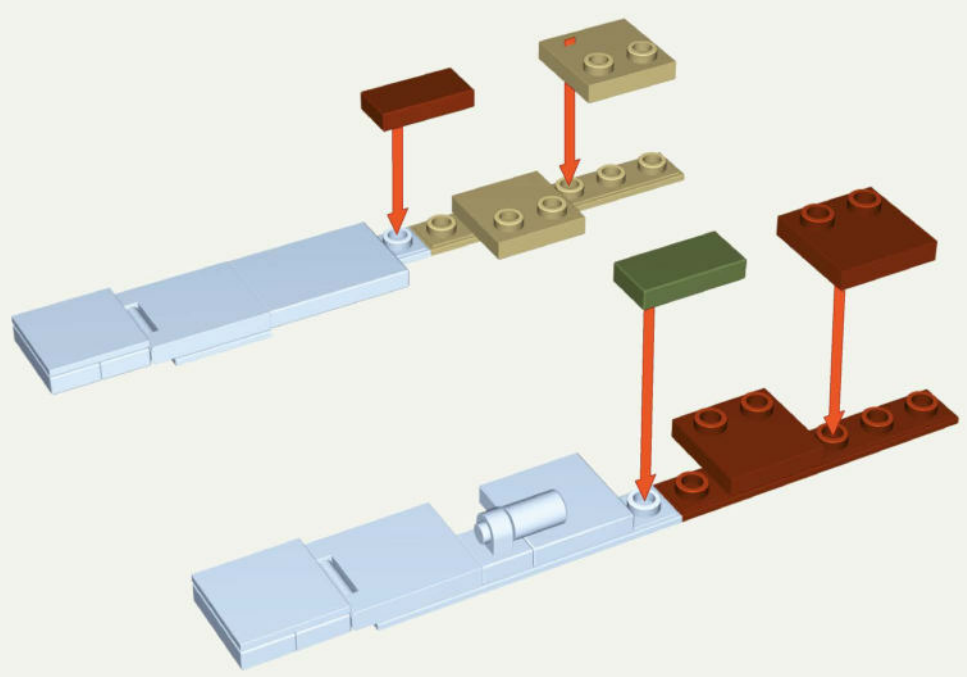





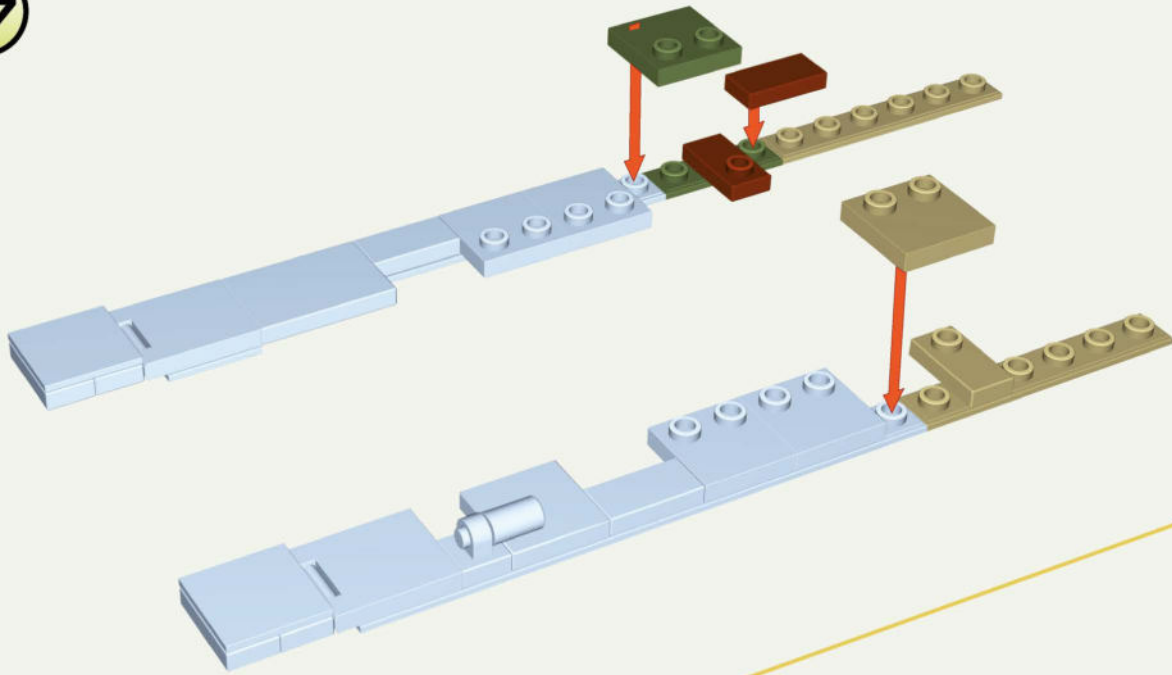

1:1

-   
**x1**
-   
**x1**
-   
**x2**
-   
**x2**
-   
**x1**
-   
**x1**

67



			
<b>x2</b>	<b>x1</b>	<b>x1</b>	<b>x1</b>
			
<b>x1</b>	<b>x1</b>	<b>x1</b>	

1:1

68

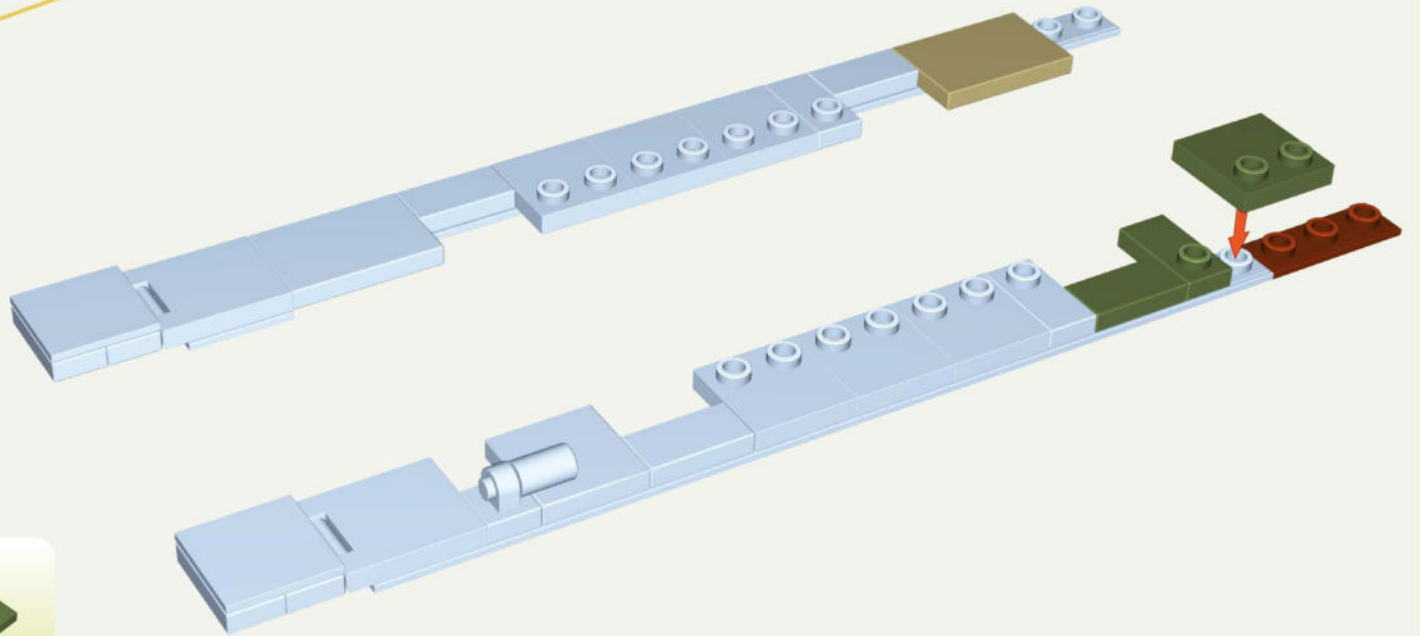

1:1

				
<b>x1</b>	<b>x1</b>	<b>x1</b>	<b>x1</b>	<b>x1</b>

69

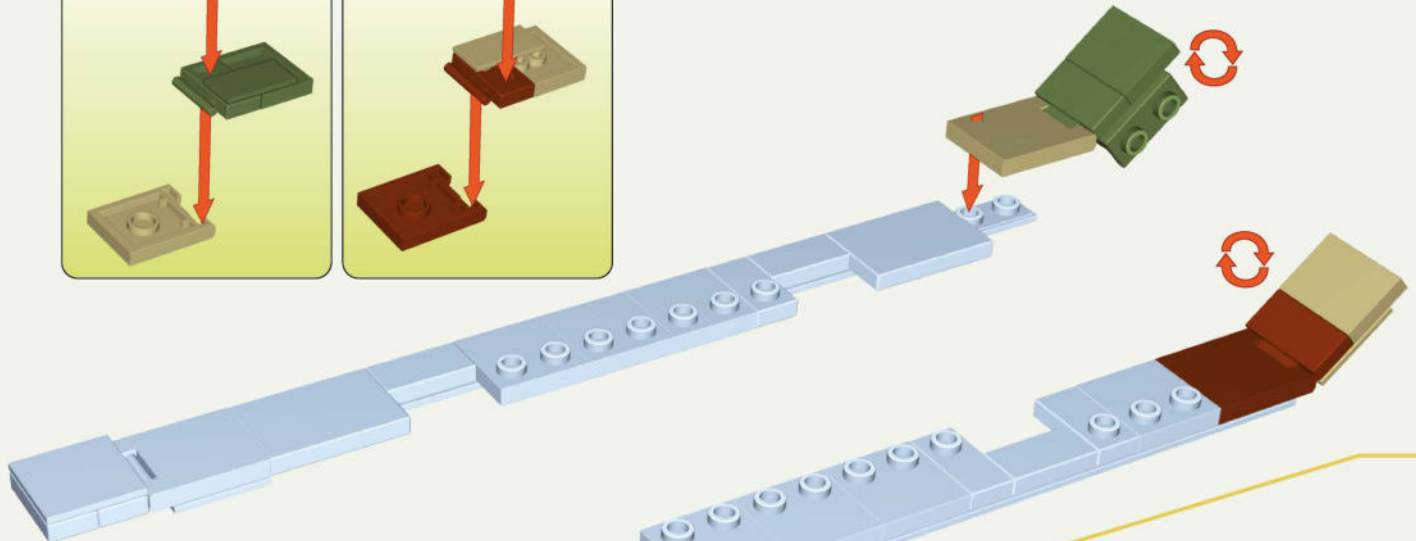
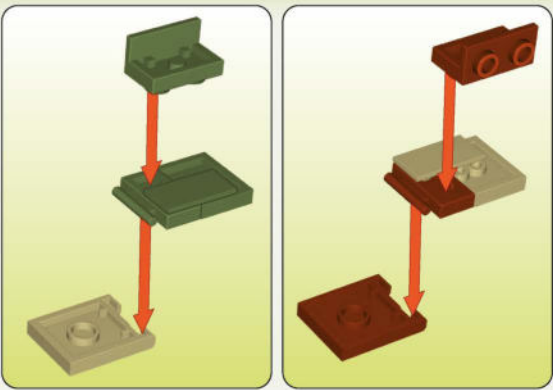

<b>x1</b>	<b>x1</b>	<b>x1</b>	<b>x1</b>
<b>x1</b>	<b>x1</b>	<b>x1</b>	<b>x1</b>
<b>x1</b>	<b>x1</b>		

70

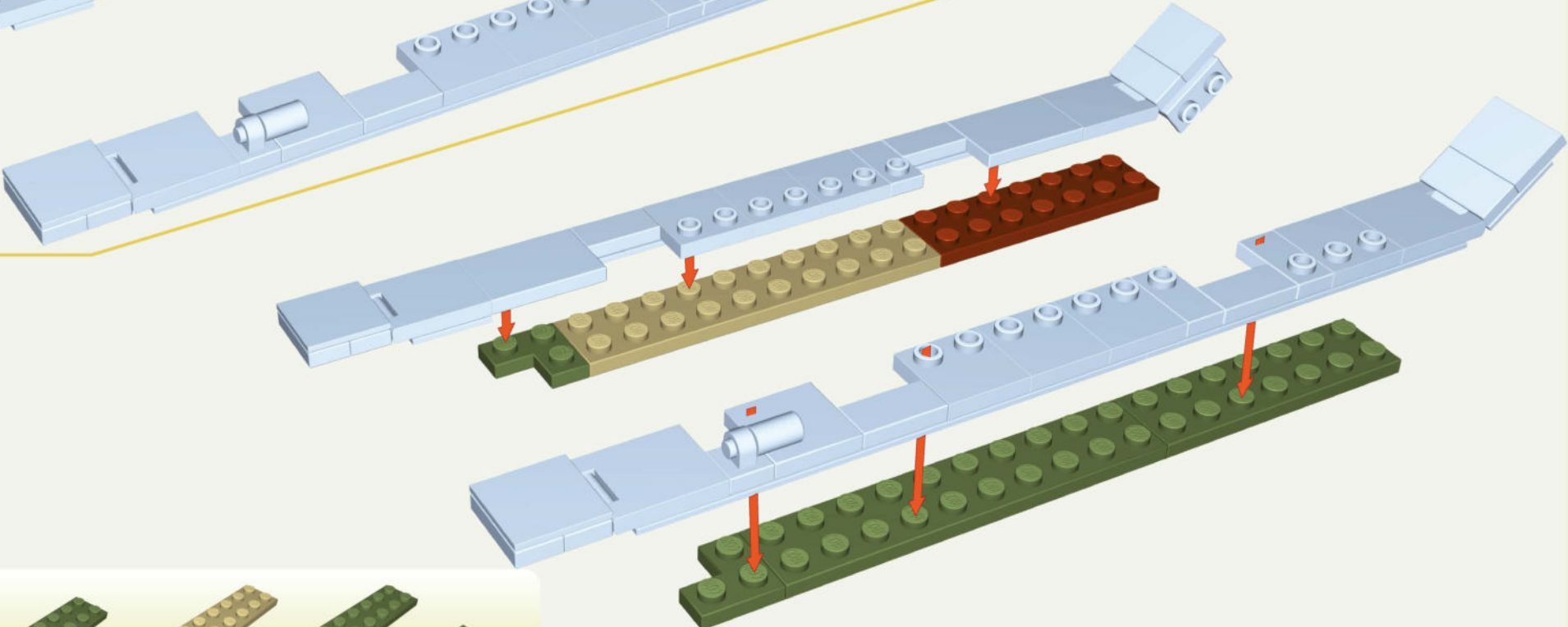

<b>x1</b>	<b>x1</b>	<b>x1</b>	<b>x1</b>	<b>x2</b>



71

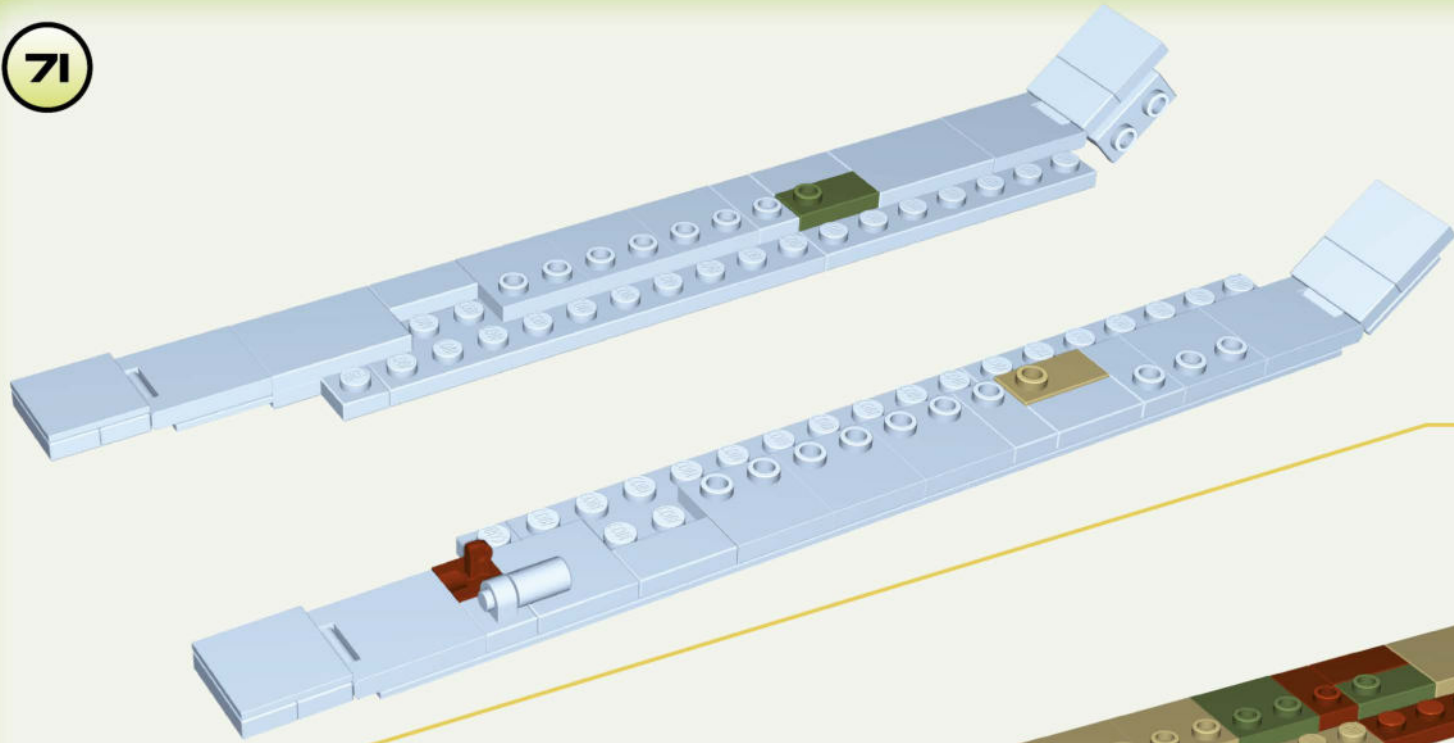

		
<b>x1</b>	<b>x1</b>	<b>x1</b>

72

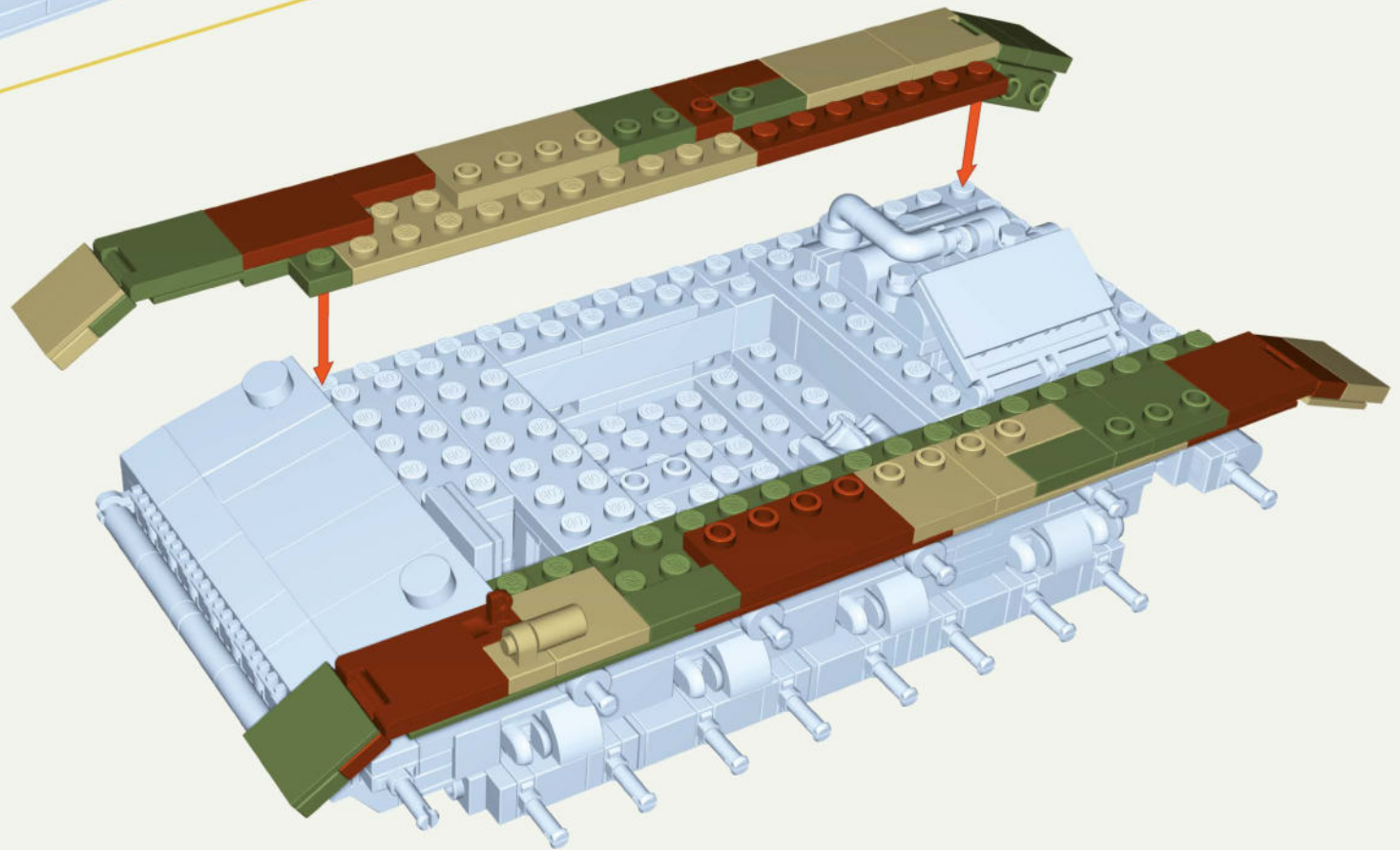

73

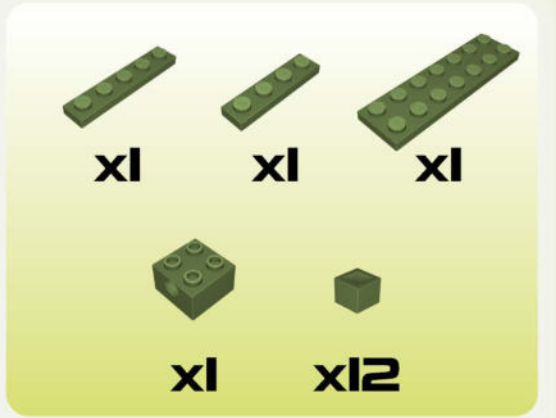
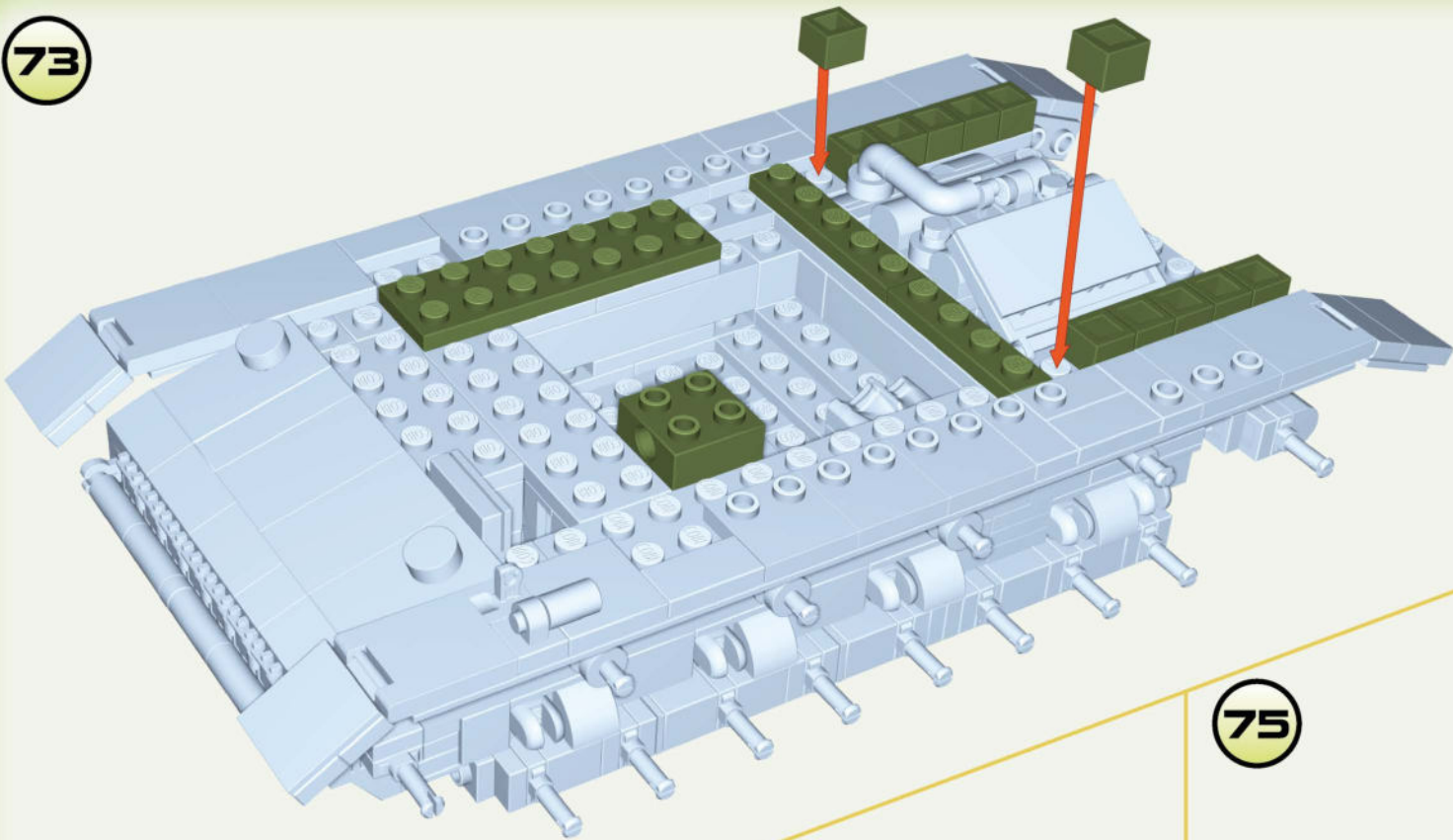

74

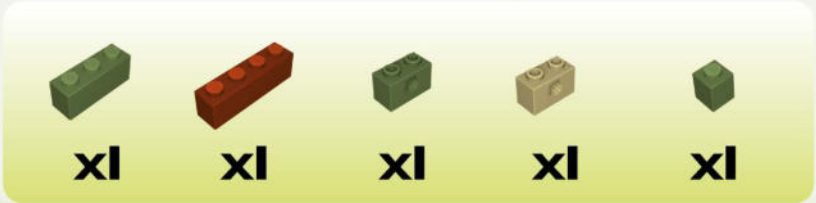
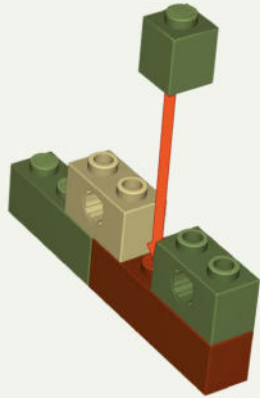

75

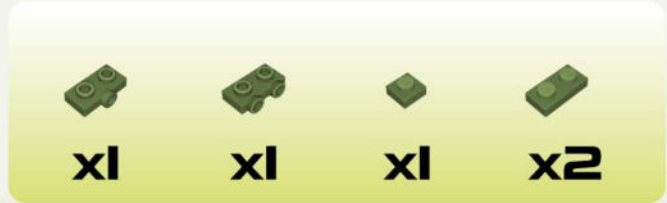
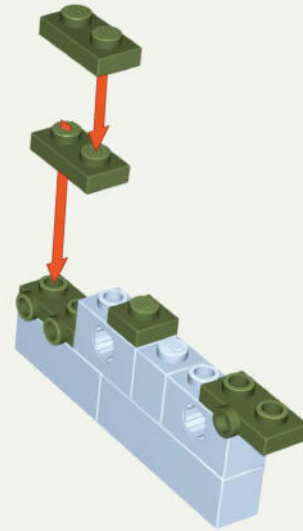

76

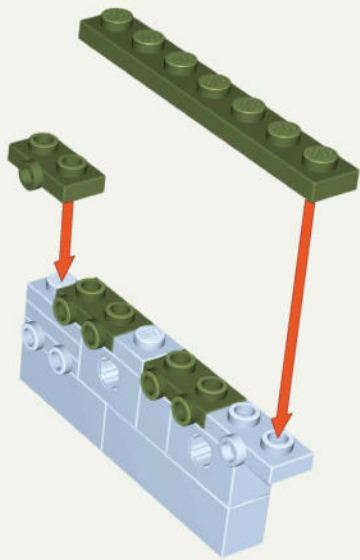

x2



x1



x1

77

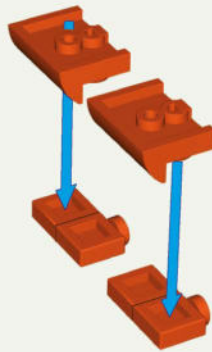

x2



x2



x2

78

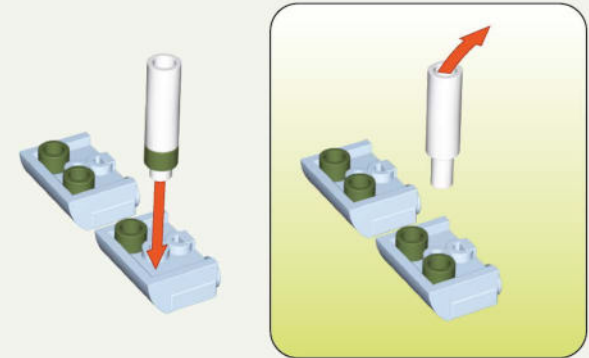

x4

79

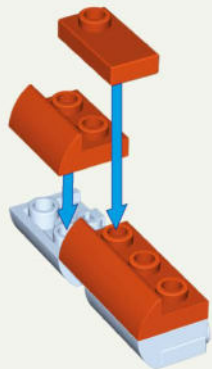

x1



x1



x1

80

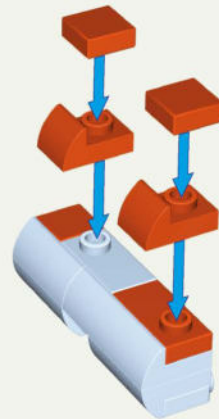

x1



x3



x2

81

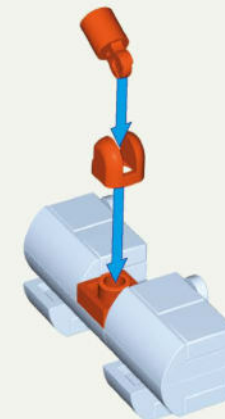

x1



x1



x1



82

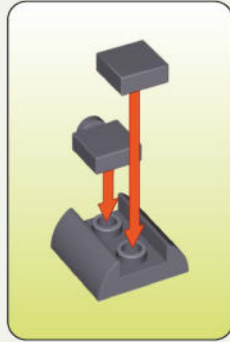
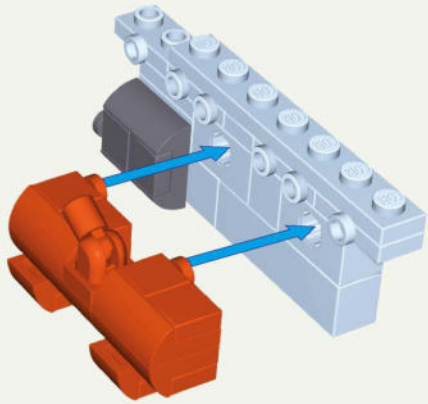

<b>x1</b>	<b>x1</b>	<b>x1</b>

83

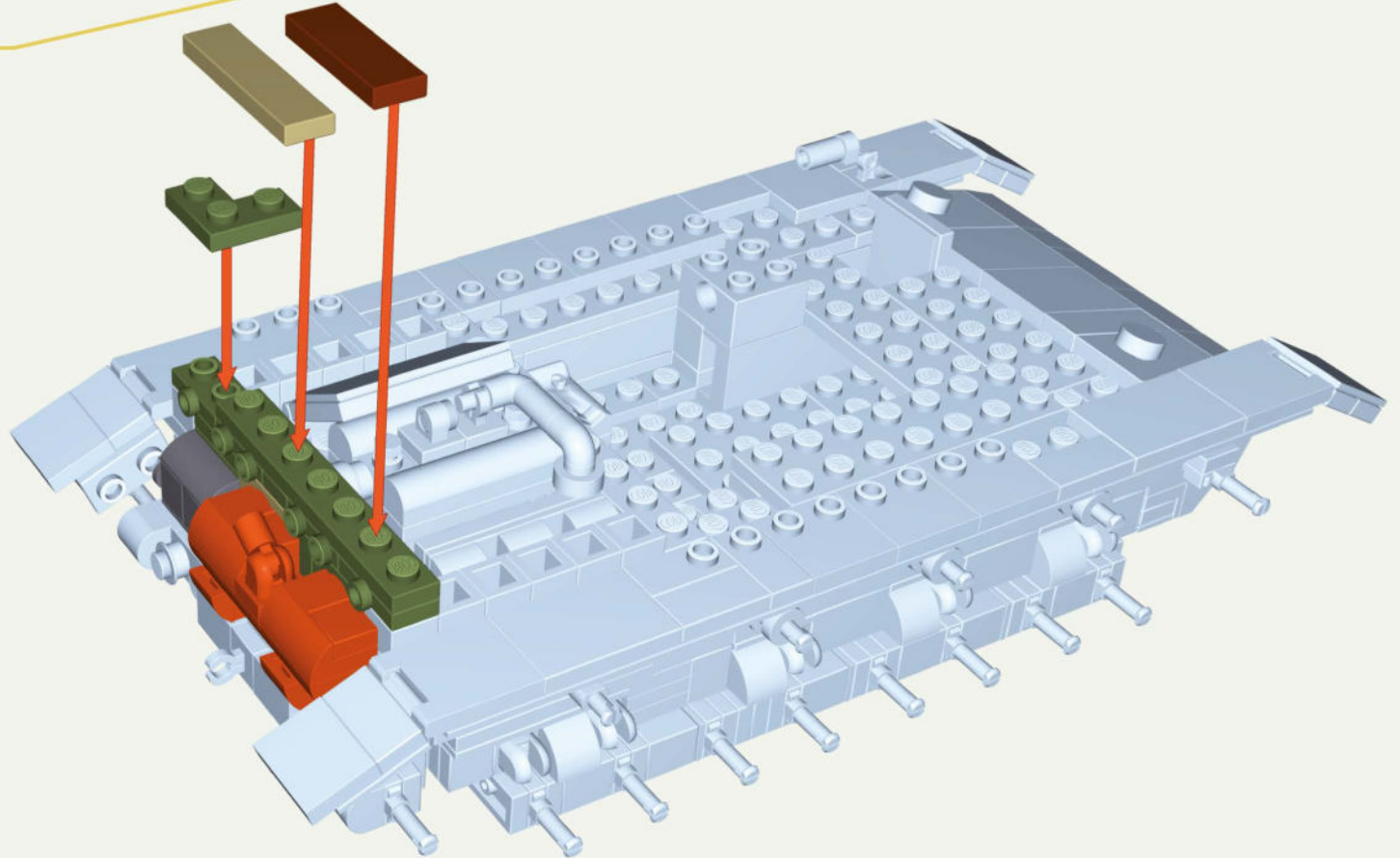

<b>1:1</b>	<b>1:1</b>
------------	------------

<b>x1</b>	<b>x1</b>	<b>x1</b>

84

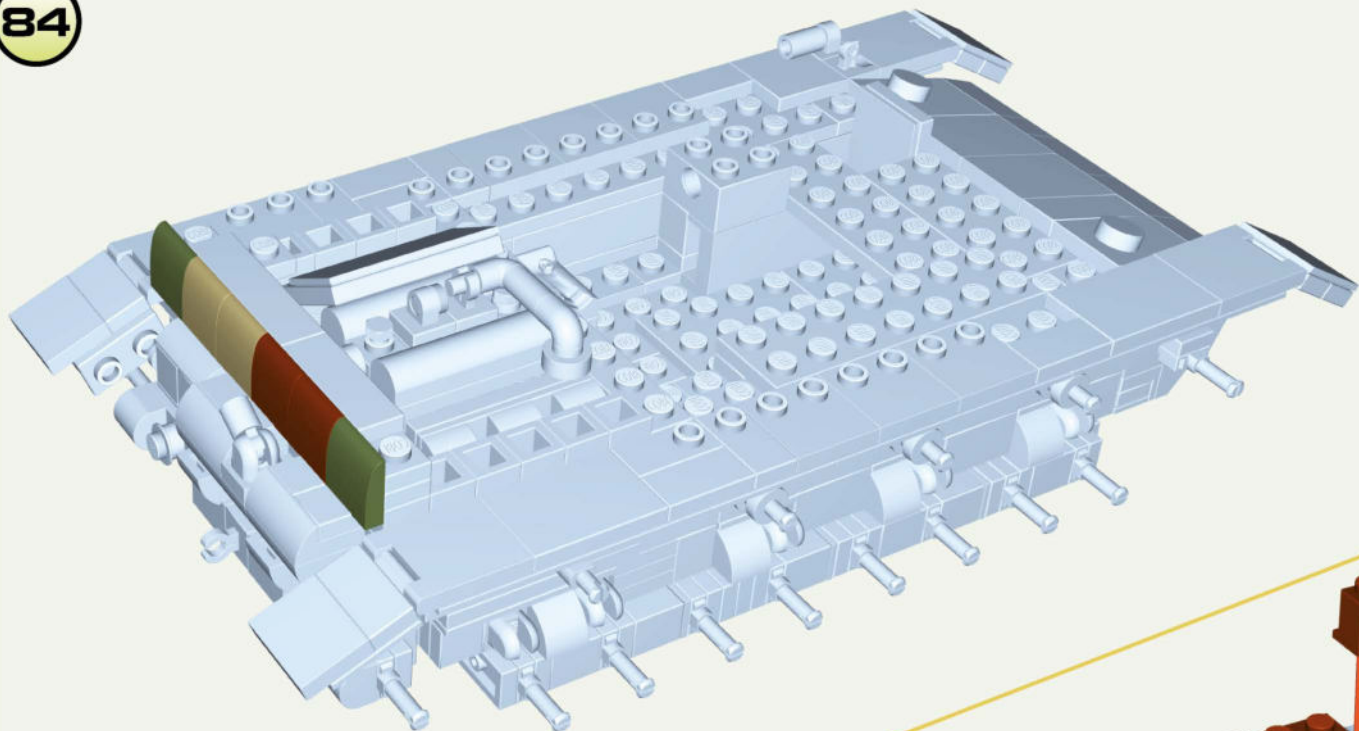

<b>x2</b>	<b>x2</b>	<b>x2</b>

85

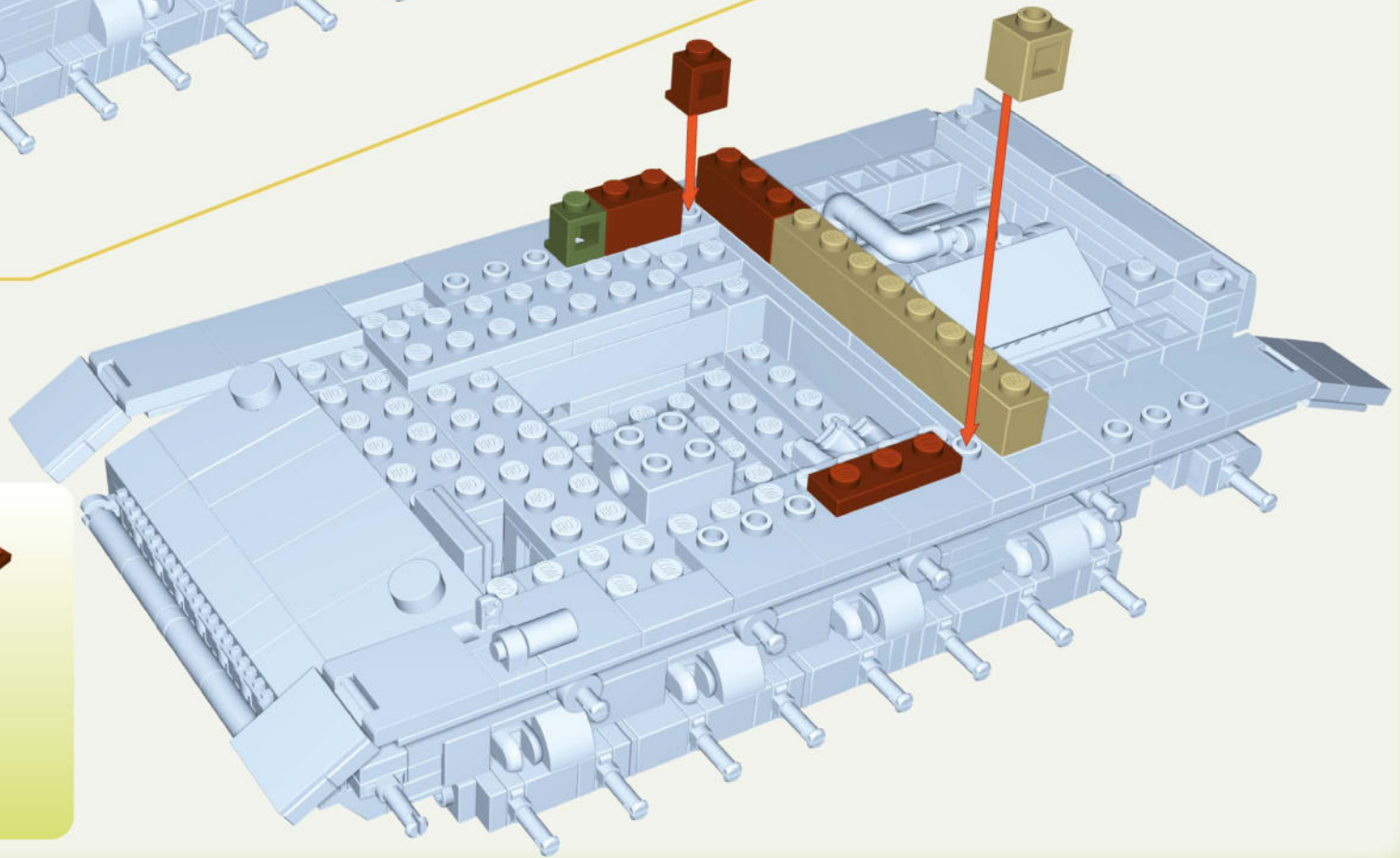

<b>x1</b>	<b>x1</b>	<b>x1</b>	<b>x1</b>
<b>x1</b>	<b>x1</b>	<b>x1</b>	



86

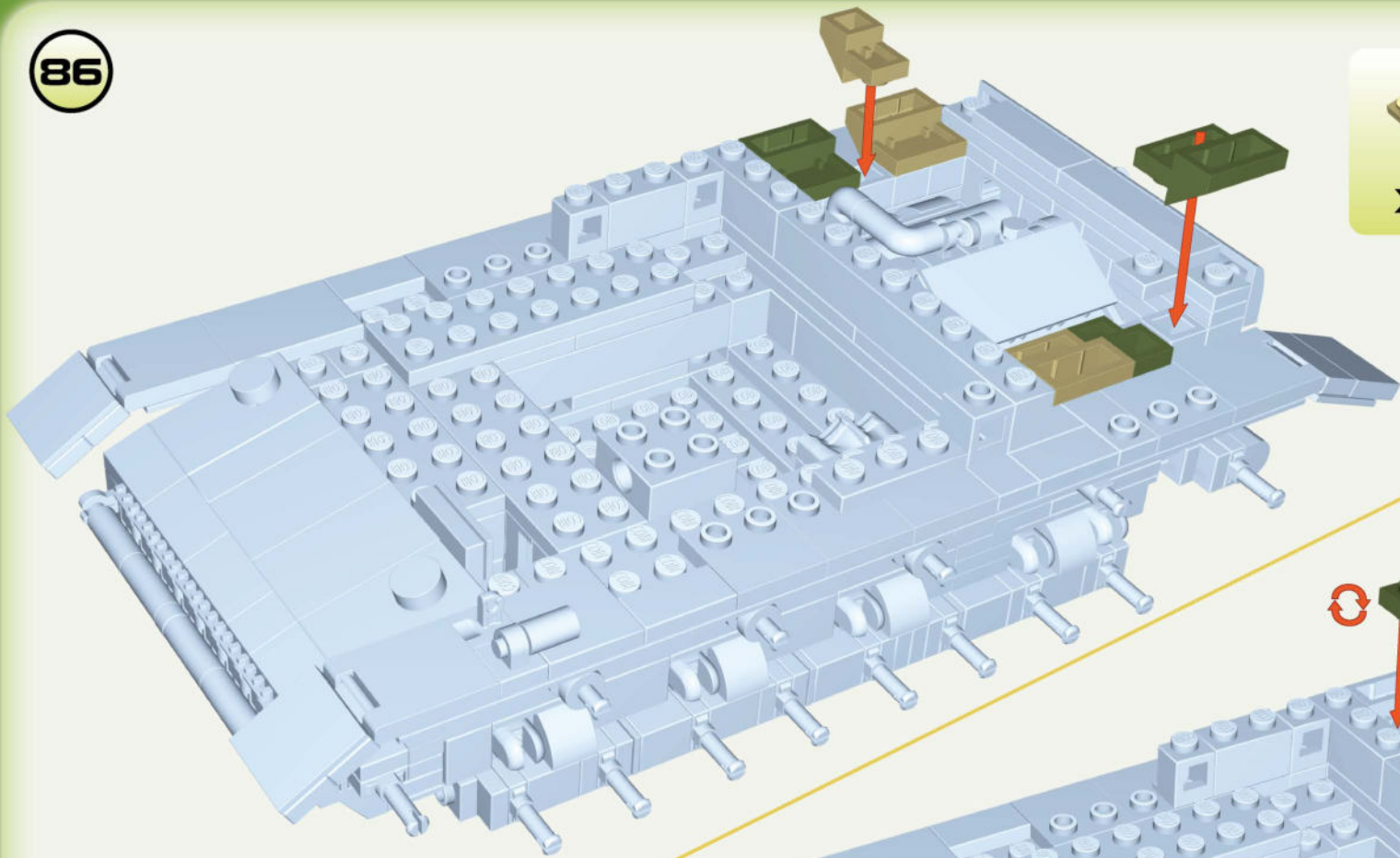

<b>x2</b>	<b>x1</b>	<b>x1</b>	<b>x2</b>

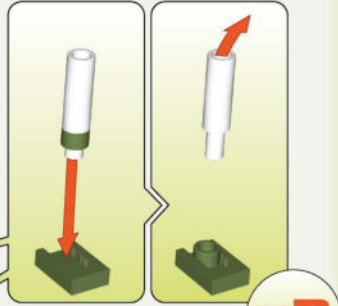

**x2**

87

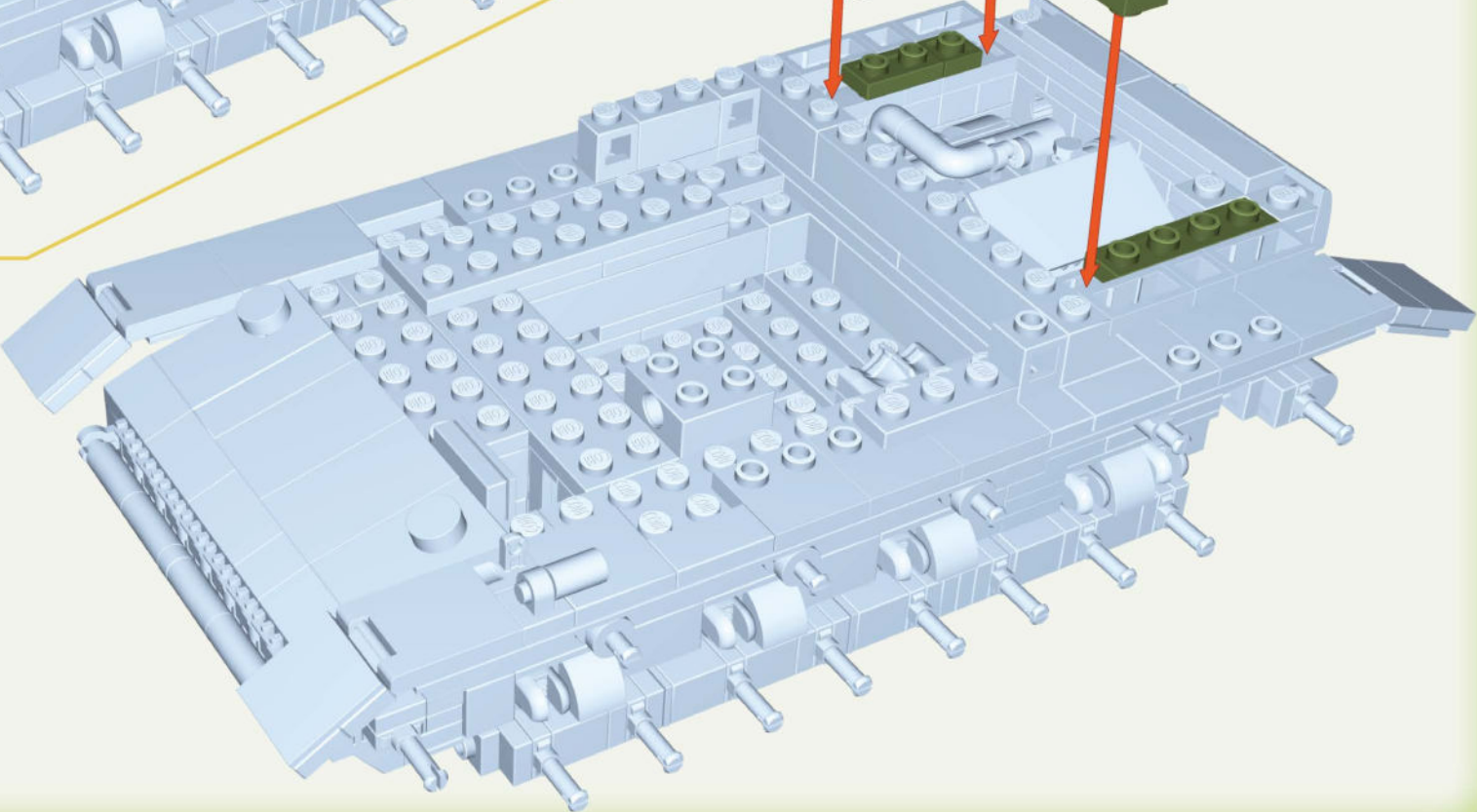

<b>x1</b>	<b>x1</b>	<b>x2</b>
<b>x2</b>	<b>x2</b>	



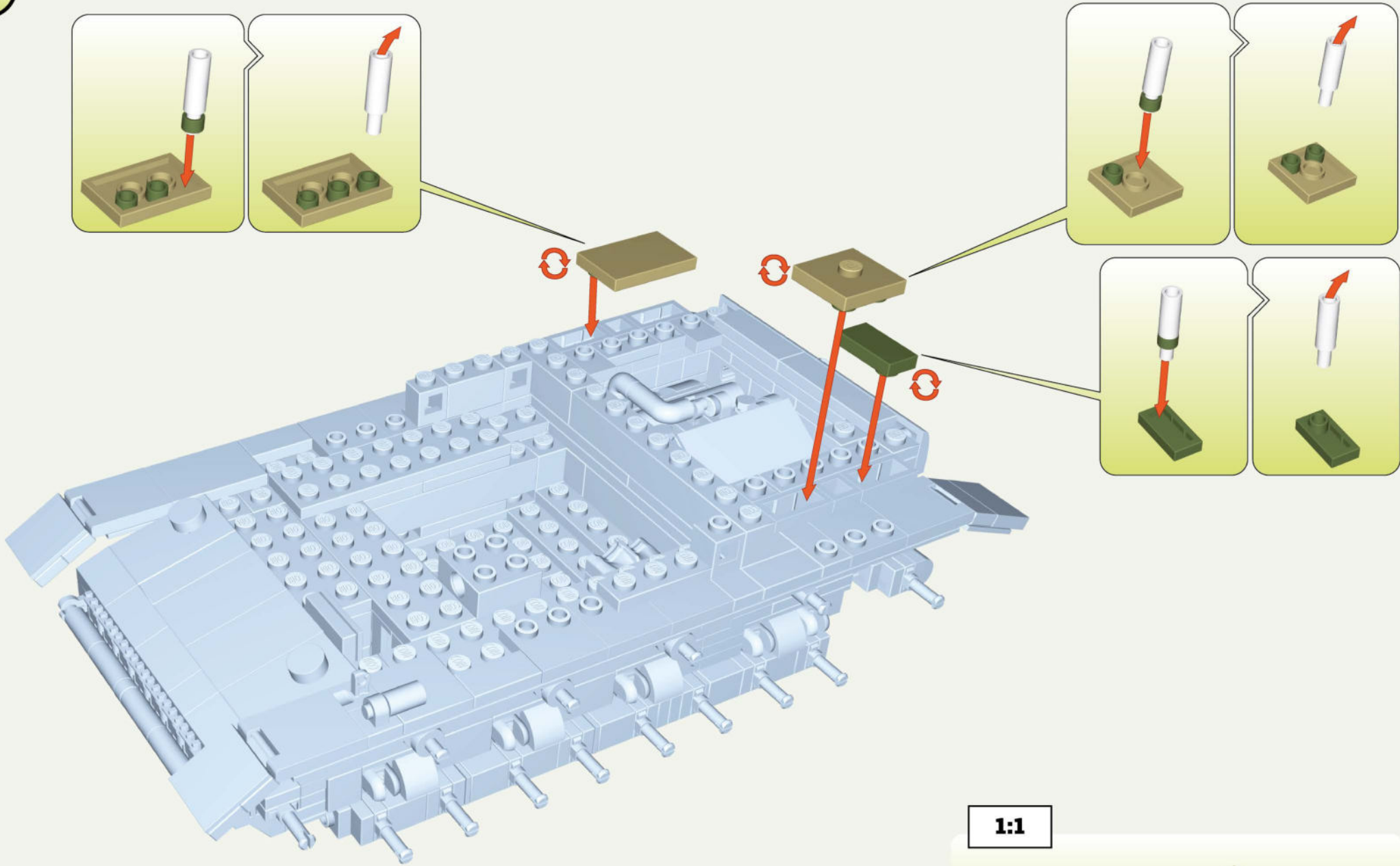

1:1



x1



x1



x1





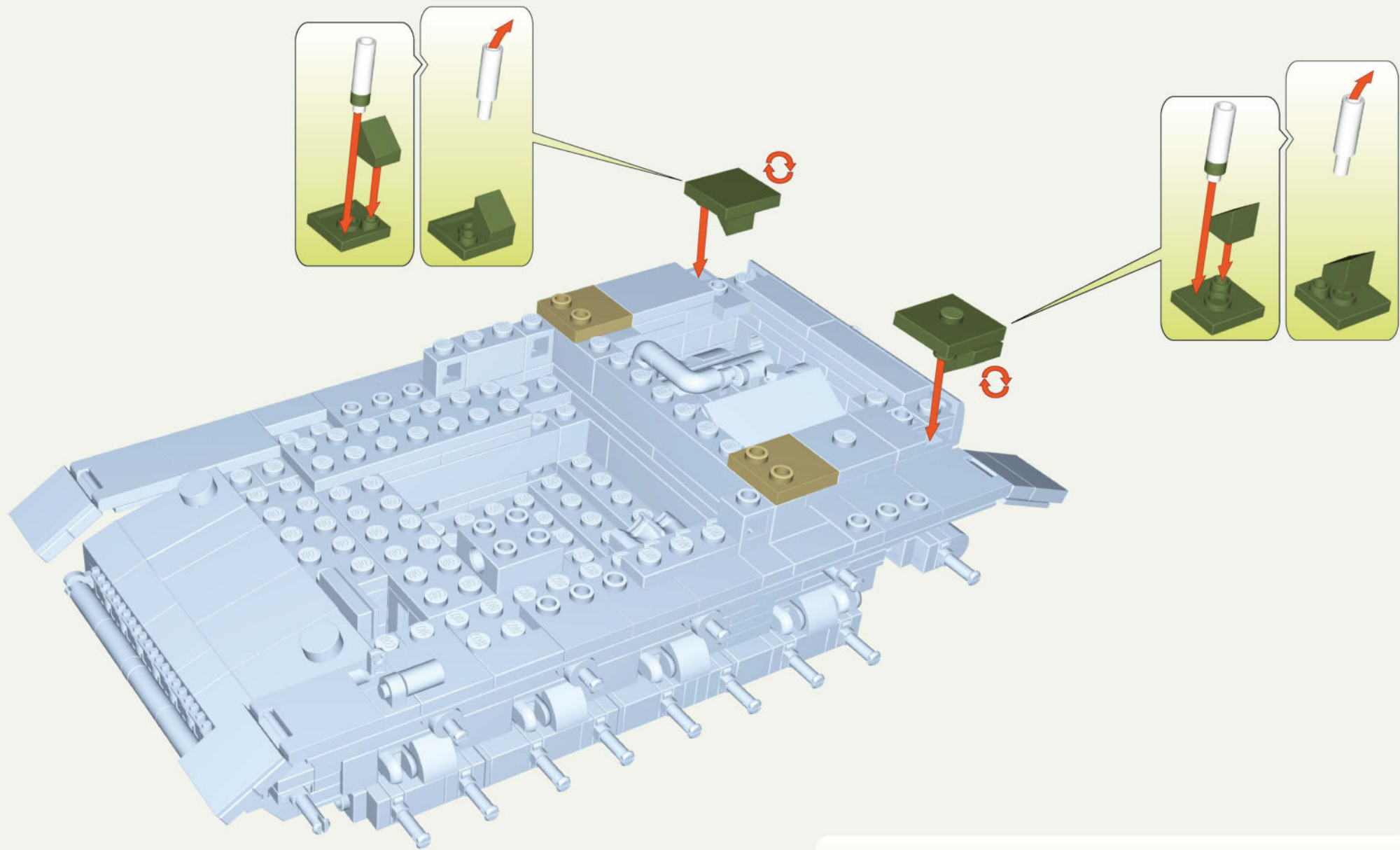



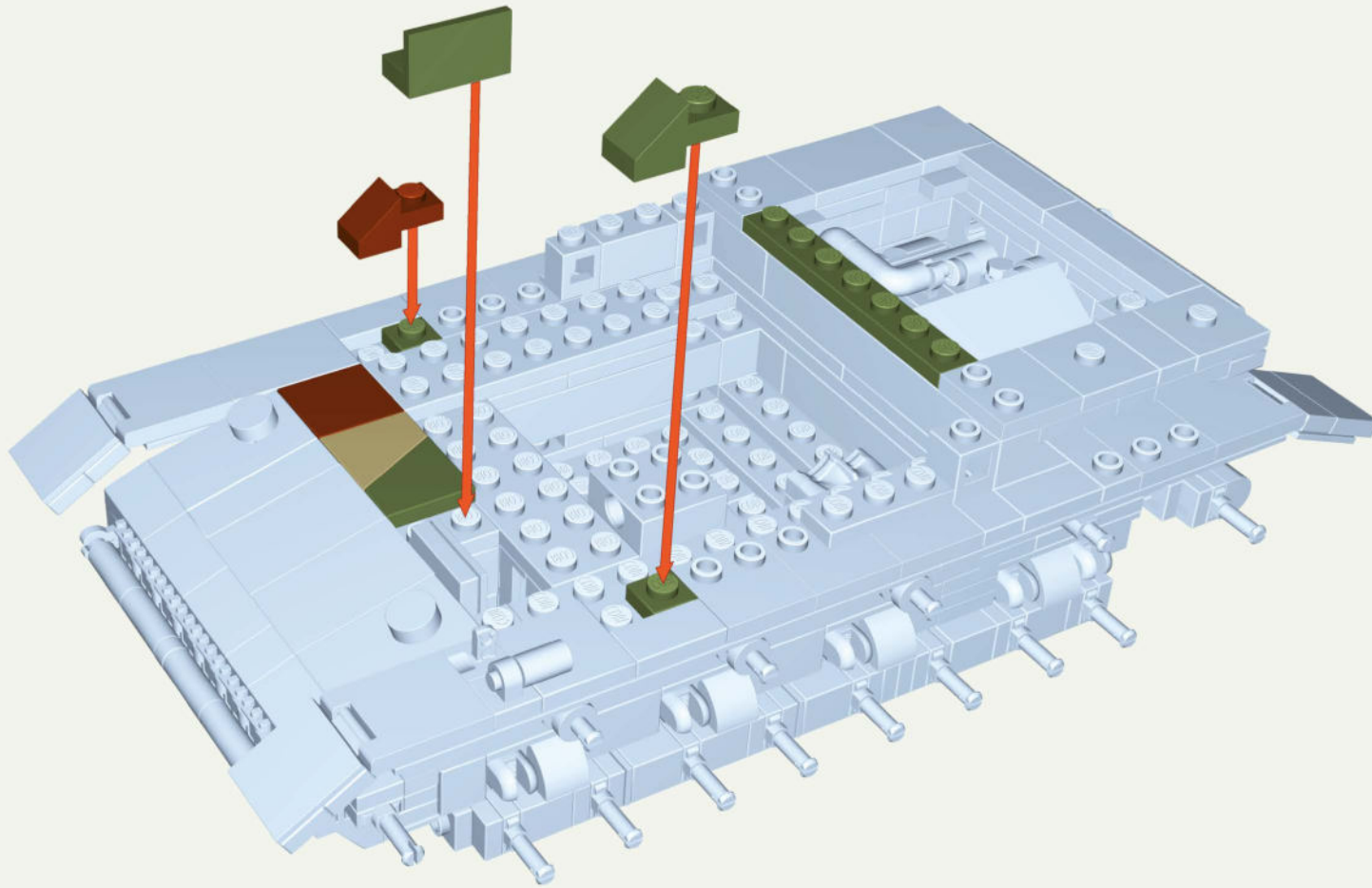

x6



-  **x2**
-  **x1**
-  **x1**
-  **x2**
-  **x4**



- |   |   |   |   |
|---|---|---|---|
|  |  |  |  |
| <b>x2</b>   | <b>x1</b>   | <b>x1</b>   | <b>x1</b>   |
|  |  |  |  |
| <b>x1</b>   | <b>x1</b>   | <b>x1</b>   | <b>x1</b>   |



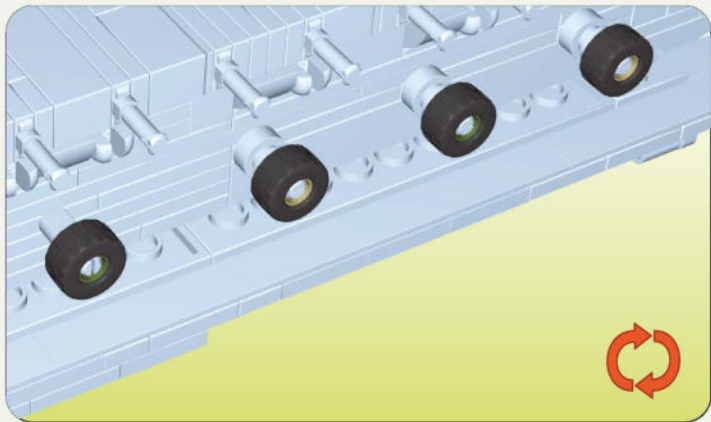
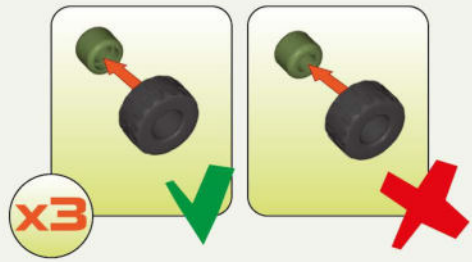
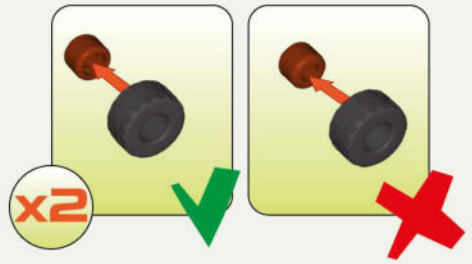
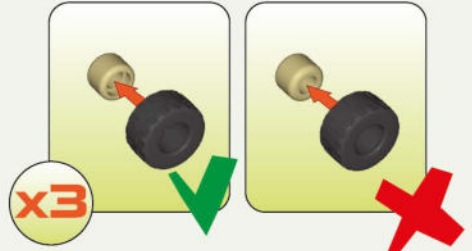
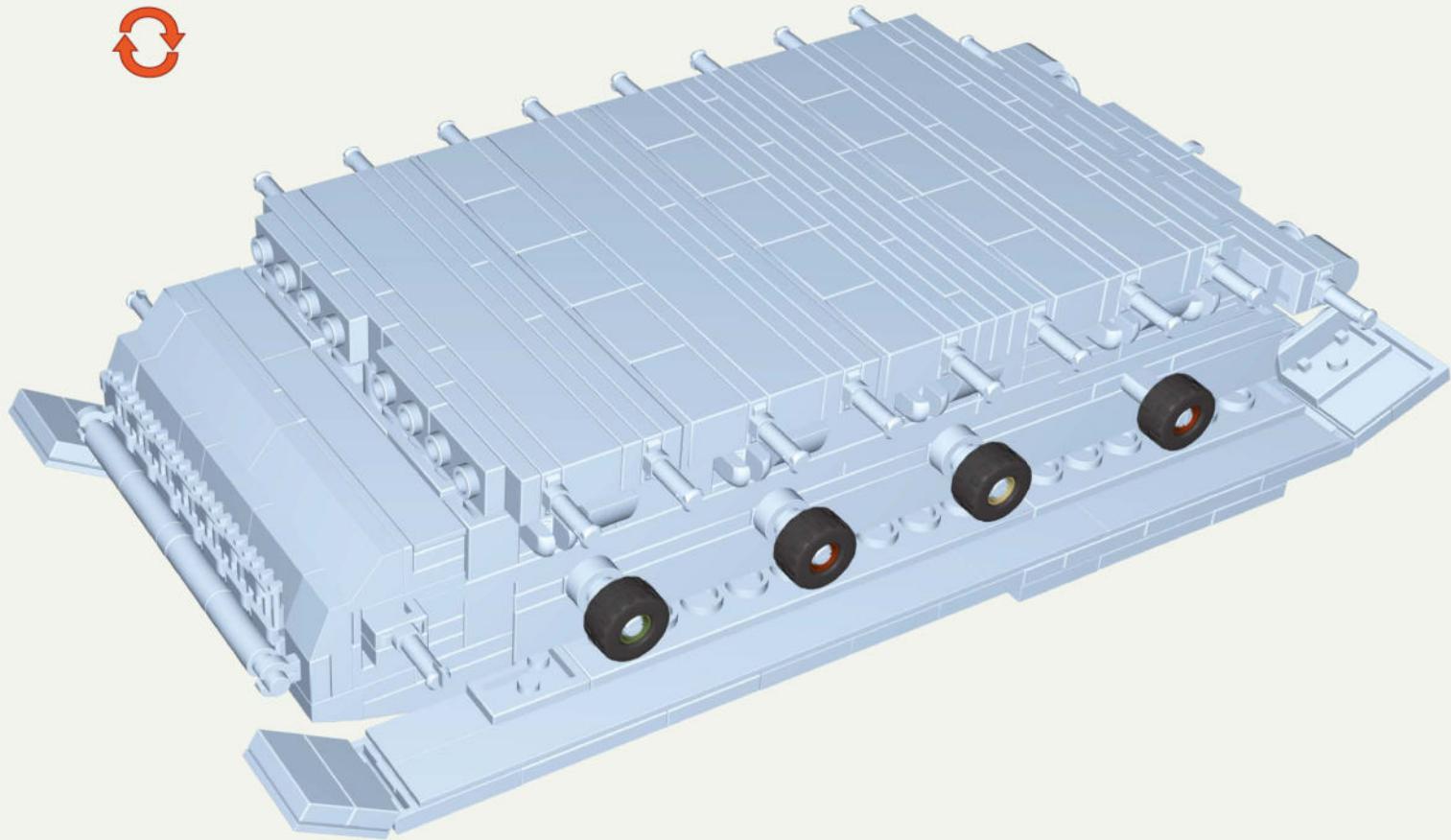

-   
**x3**
-   
**x2**
-   
**x3**
-   
**x8**

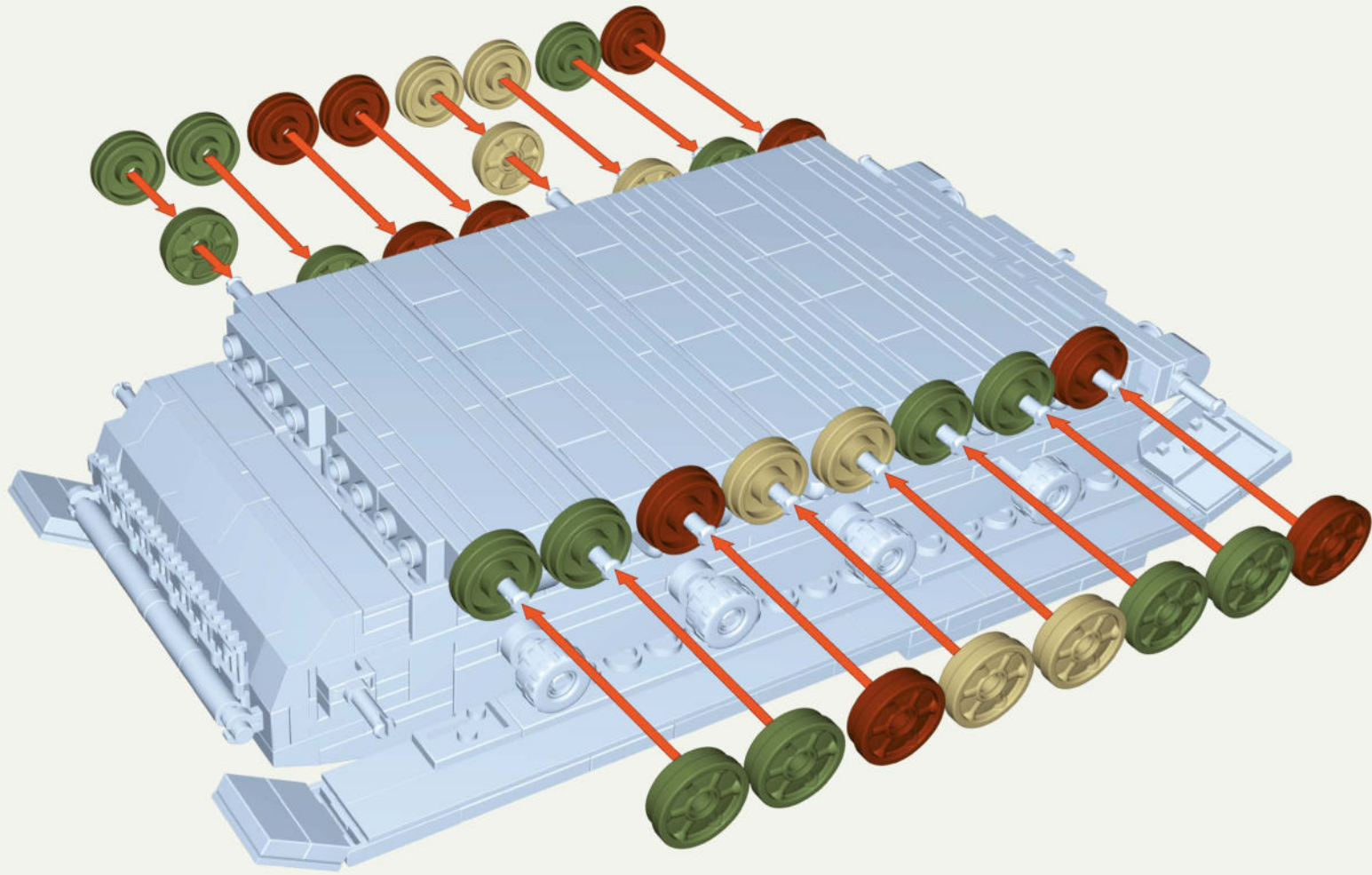

		
<b>x10</b>	<b>x14</b>	<b>x8</b>

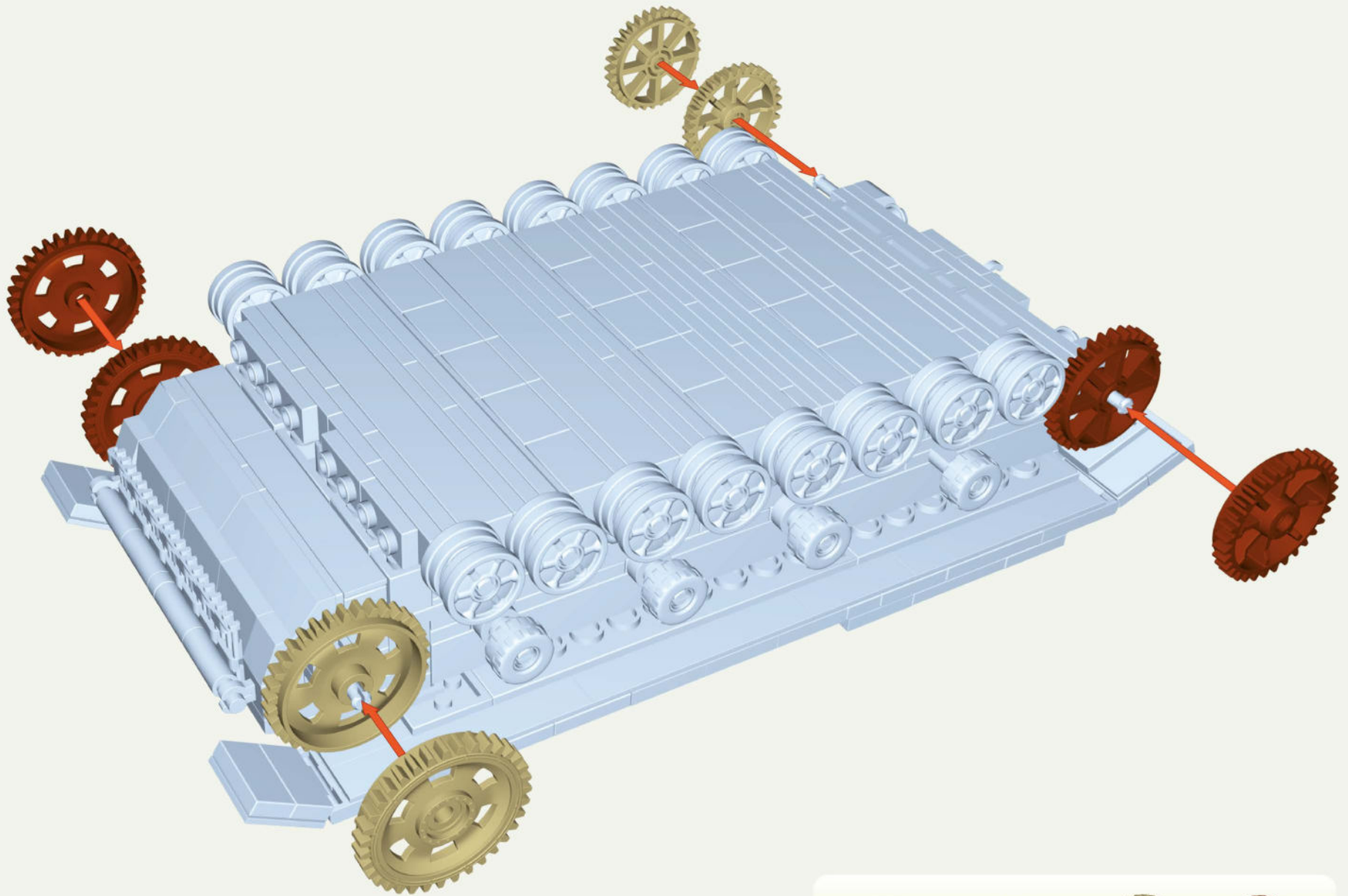

-  x2
-  x2
-  x2
-  x2



94



3

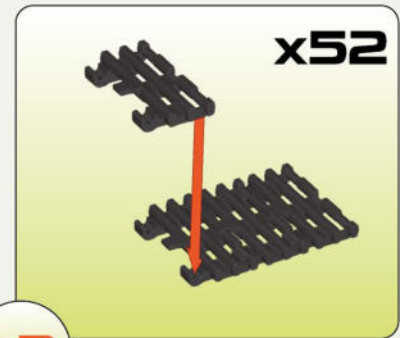
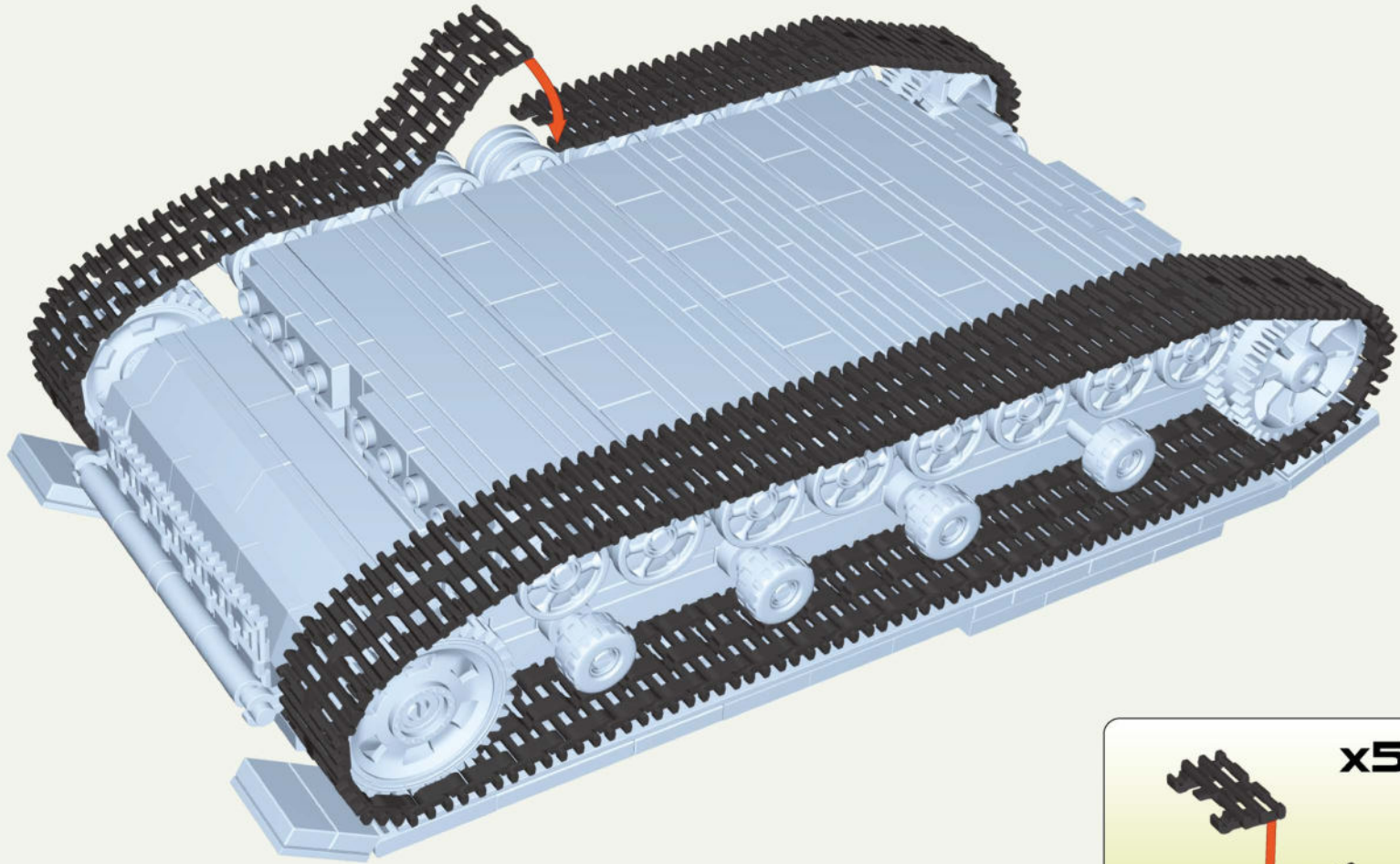

x2



x104

95

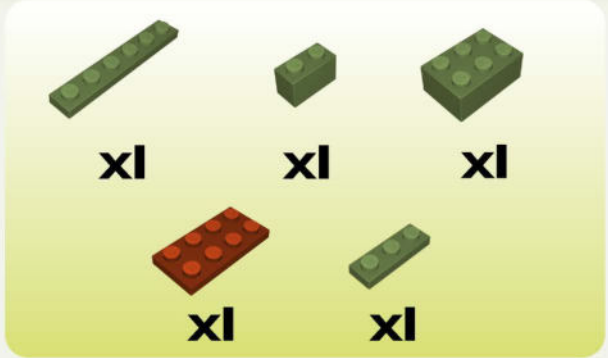
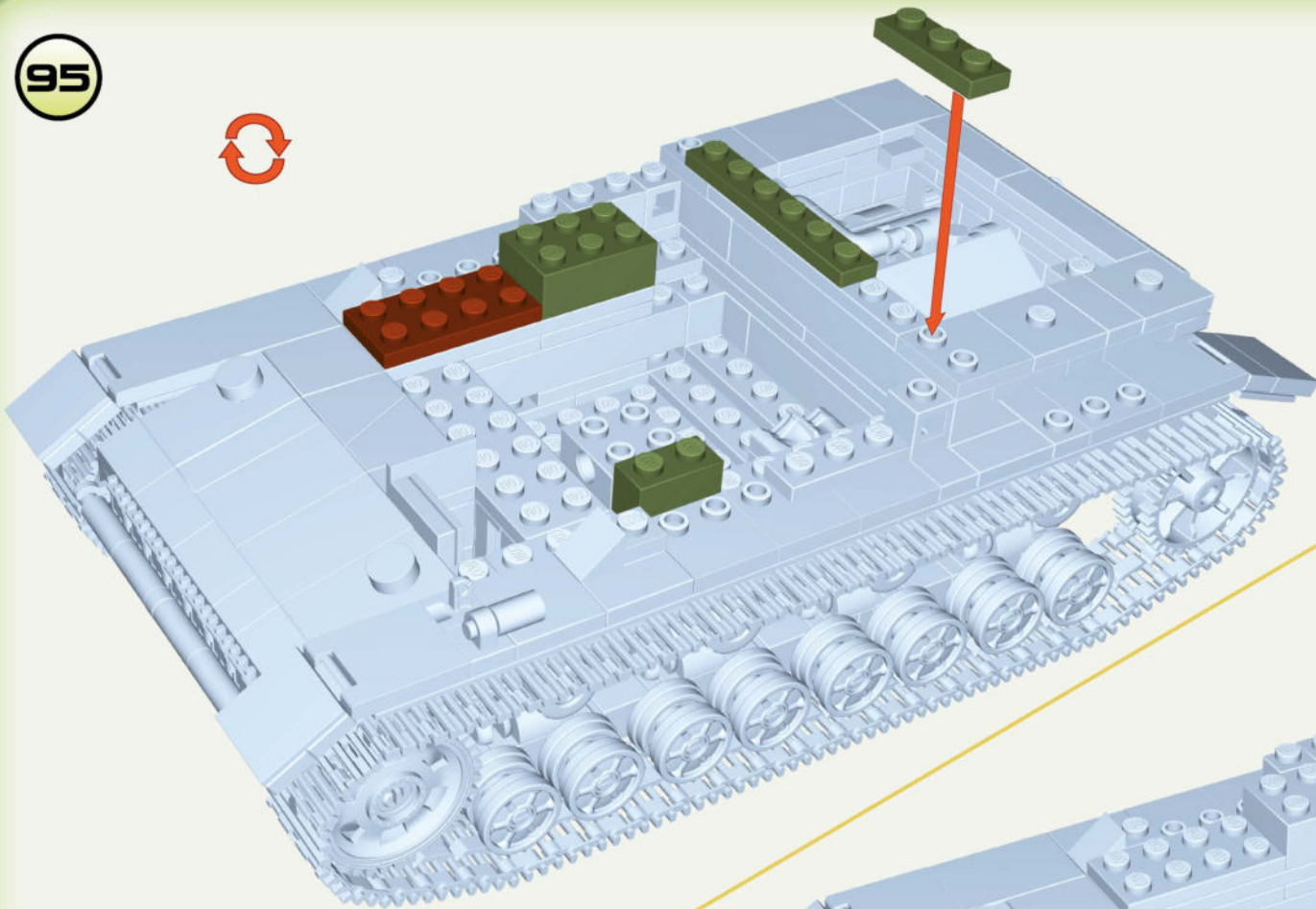

96

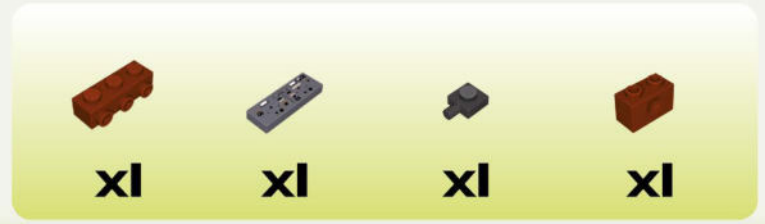
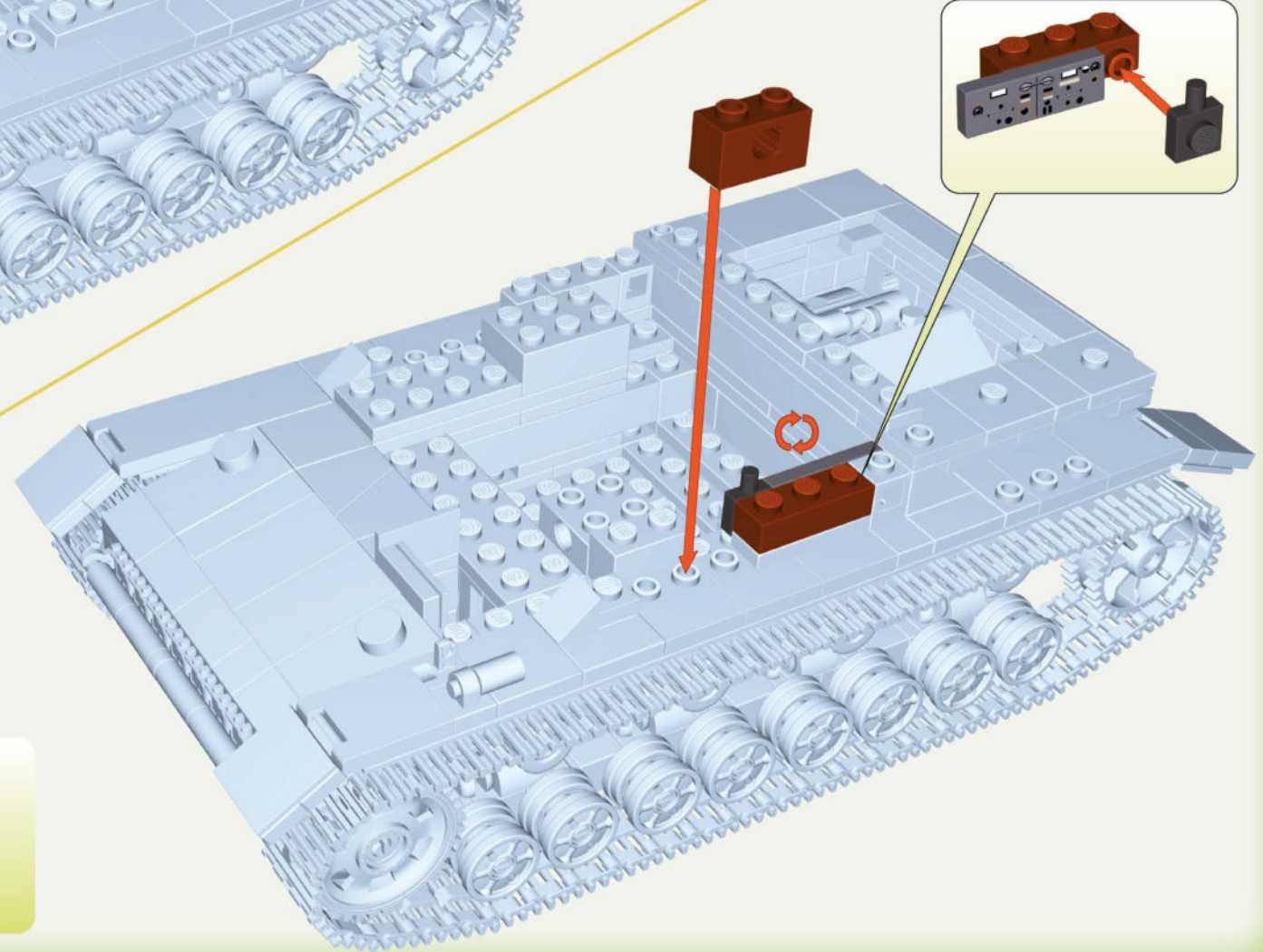



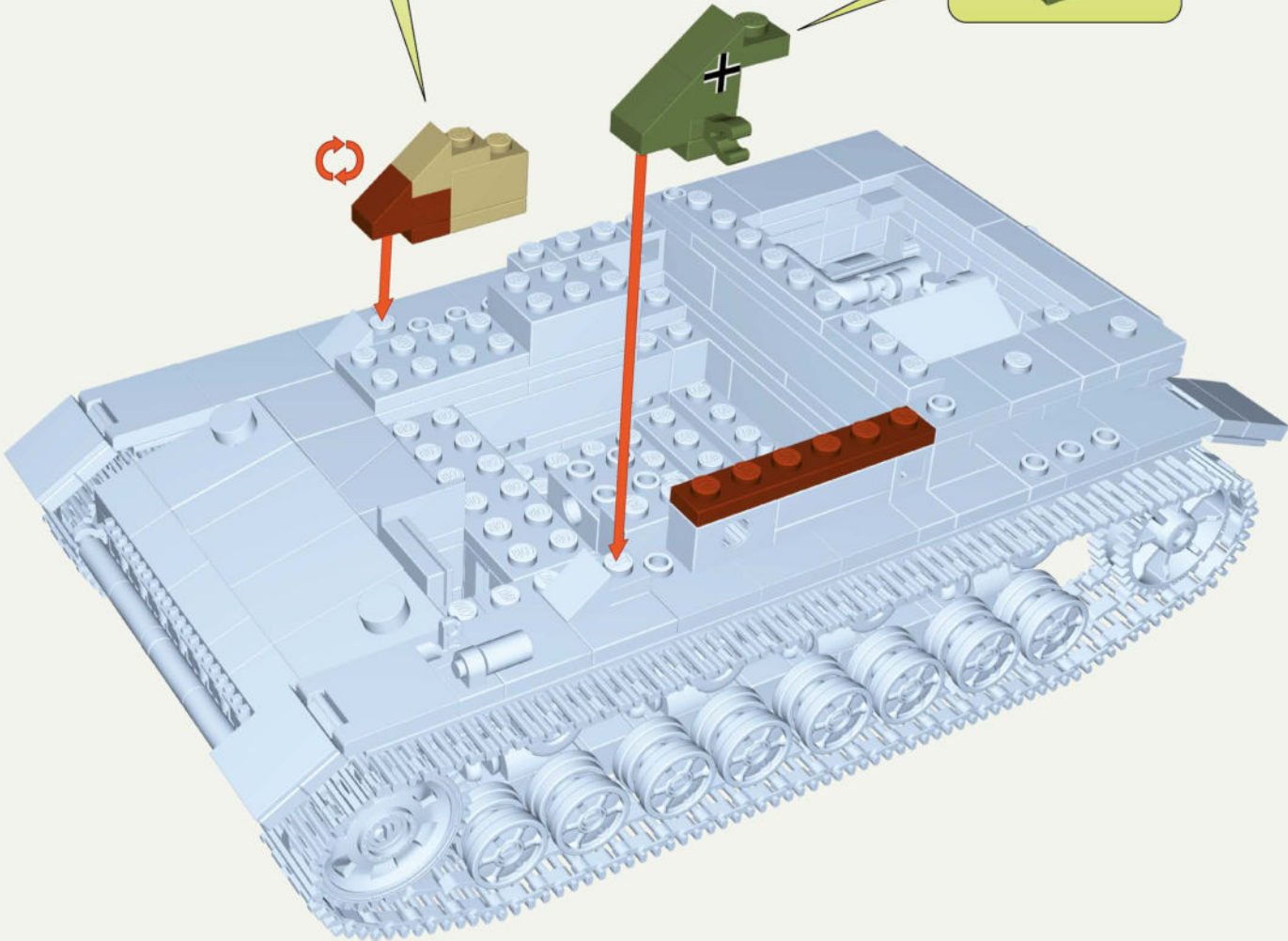
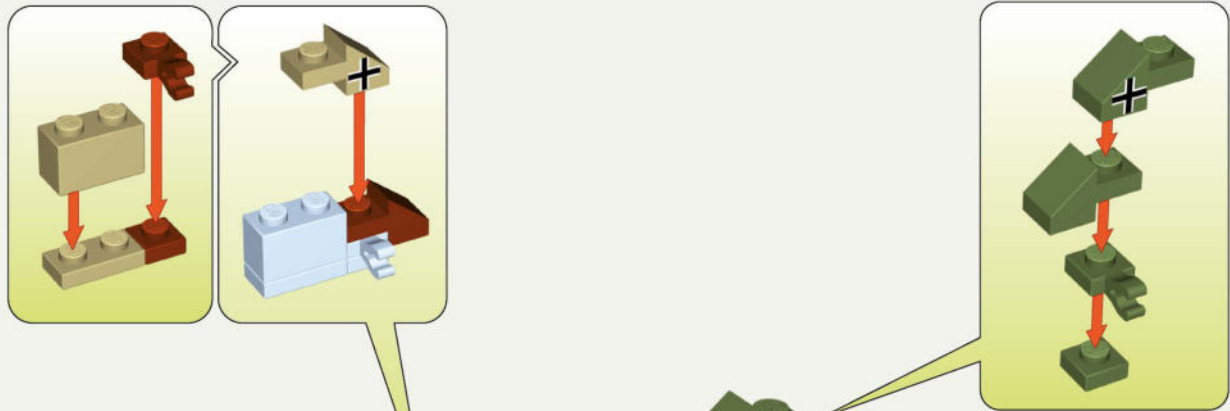





- |           |           |           |
|-----------|-----------|-----------|
|           |           |           |
| <b>x1</b> | <b>x1</b> | <b>x1</b> |
|           |           |           |
| <b>x1</b> | <b>x1</b> | <b>x1</b> |
|           |           |           |
| <b>x1</b> | <b>x1</b> | <b>x1</b> |
|           |           |           |
| <b>x1</b> | <b>x1</b> |           |

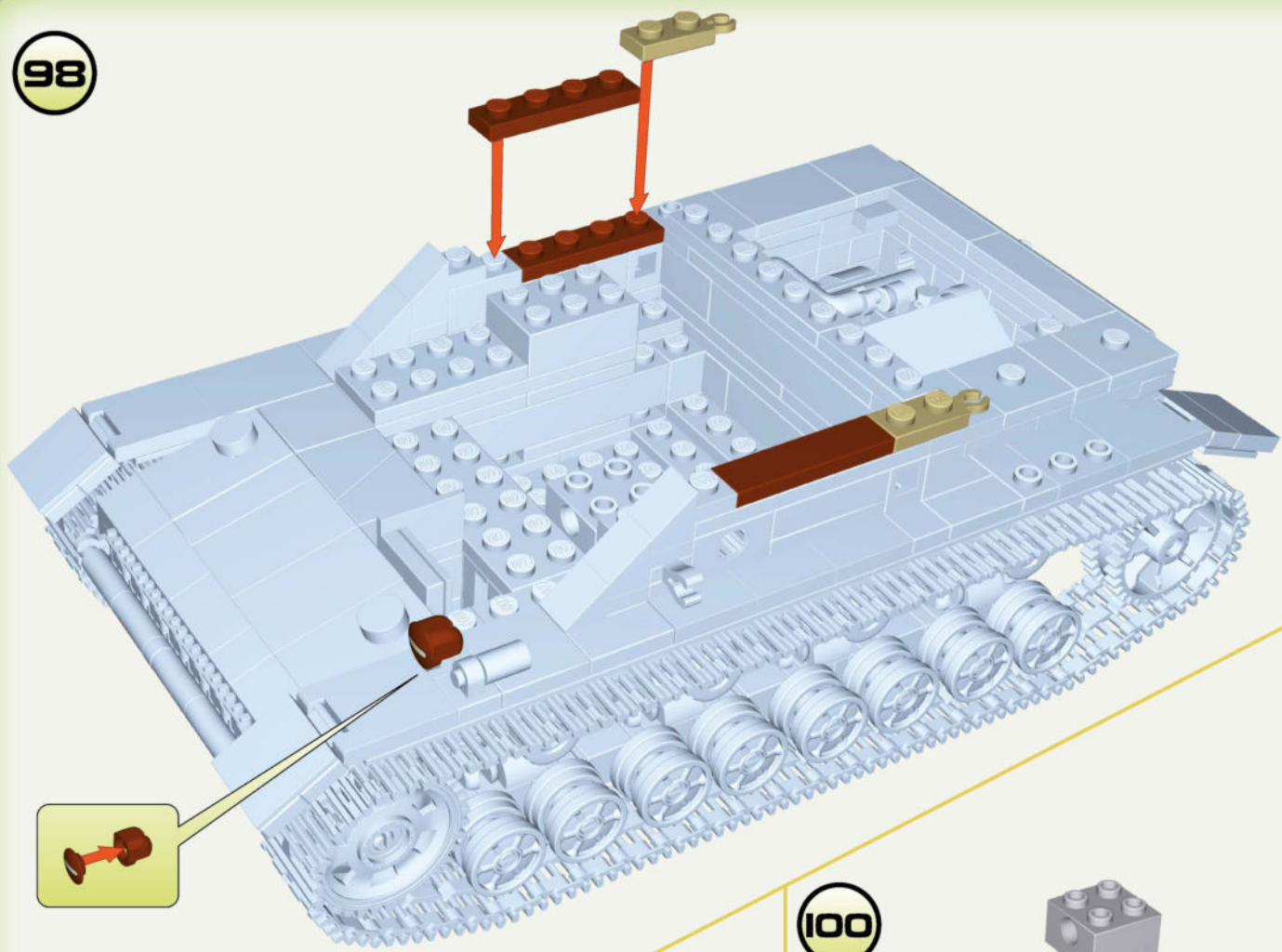

98



-   
x1
-   
x1
-   
x2
-   
x2

1:1



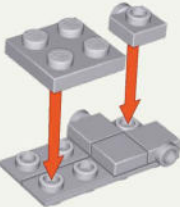

99

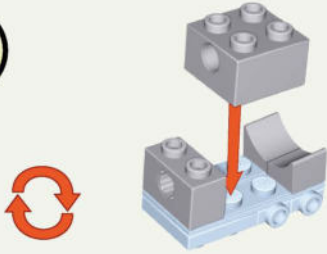

-   
x2
-   
x1
-   
x2
-   
x1
-   
x1

100



-   
x2
-   
x1
-   
x1

101

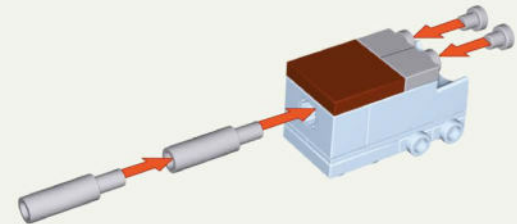

-   
x1
-   
x2
-   
x2
-   
x2

102

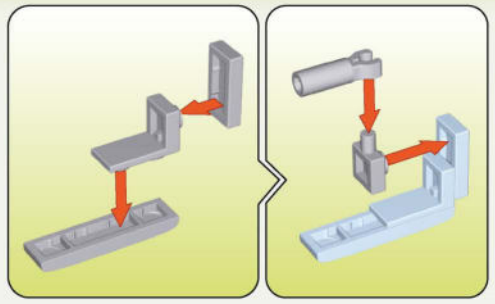
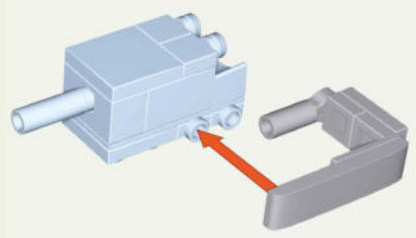

1:1

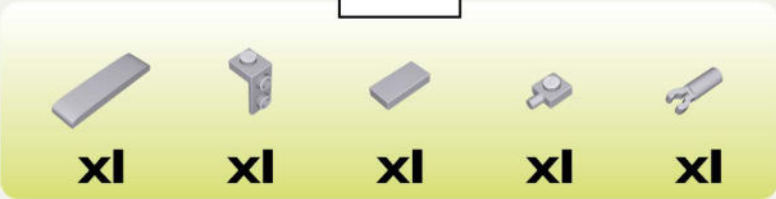

103

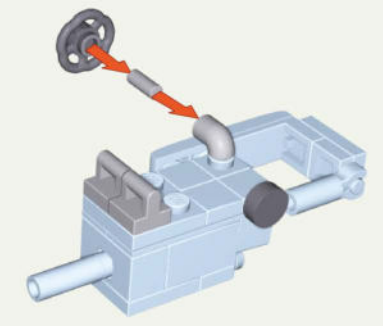

104

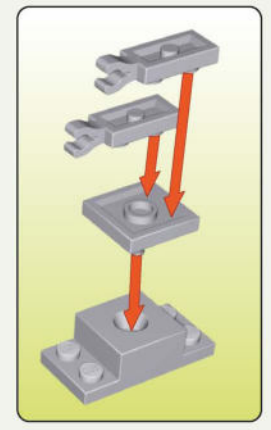
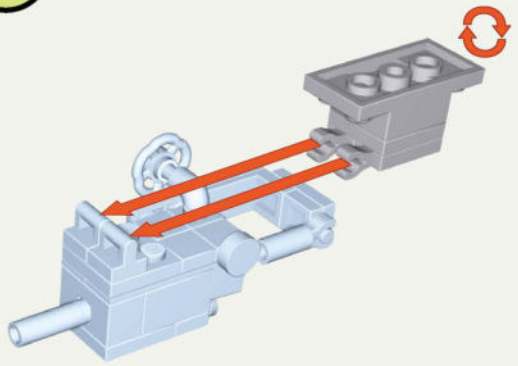

105

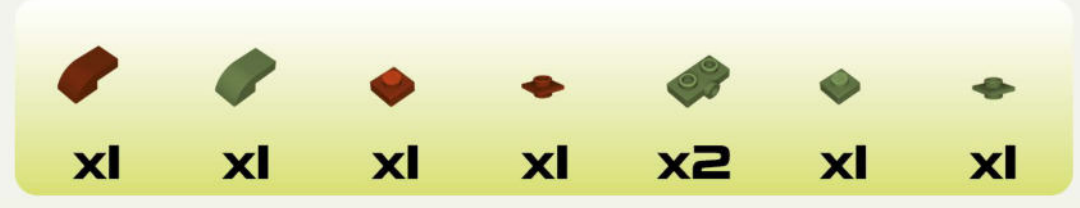
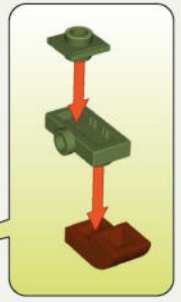
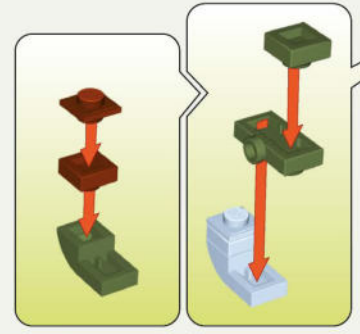
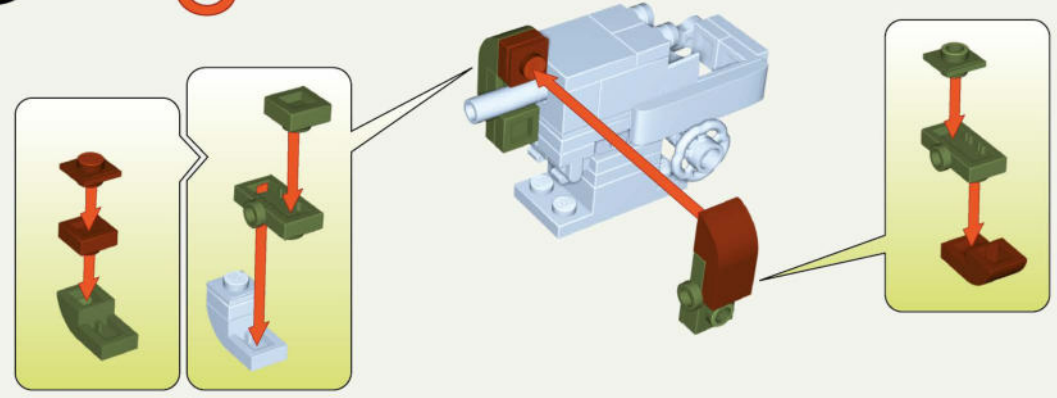

106

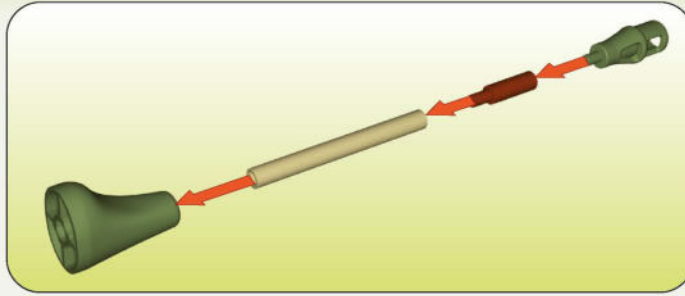
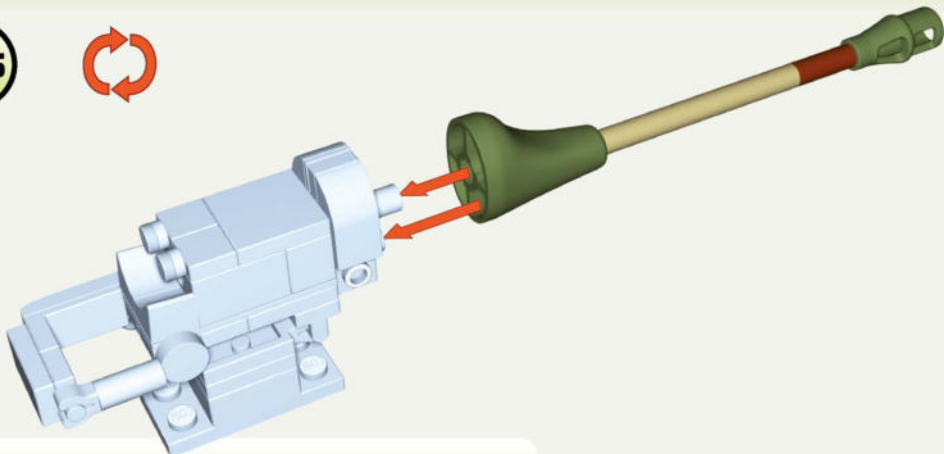

x1



x1



x1



x1

107

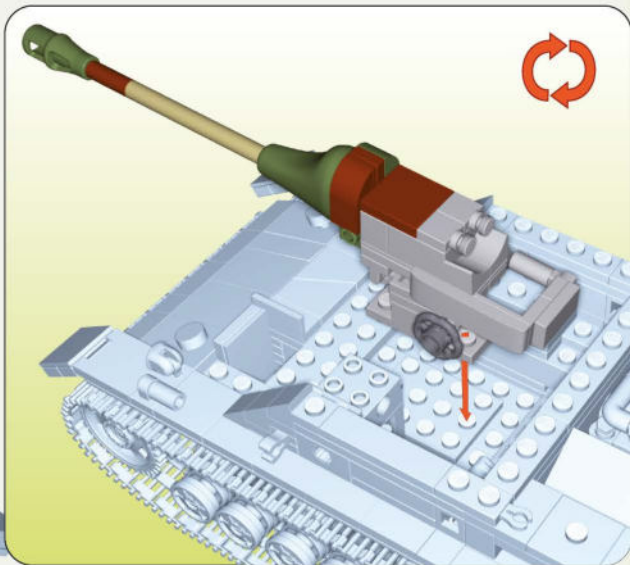
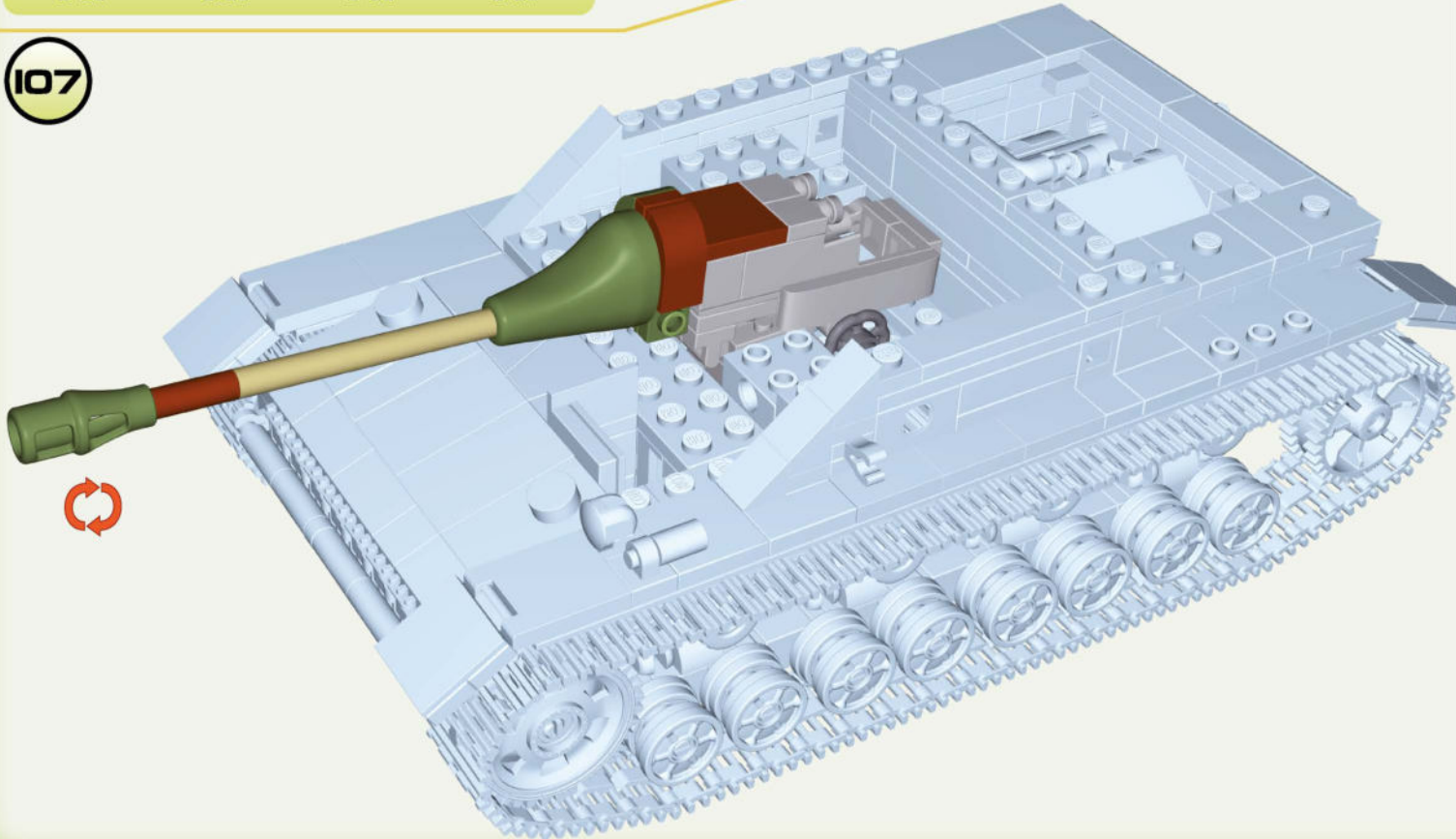



108

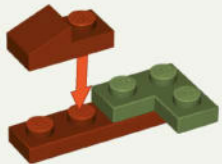

109

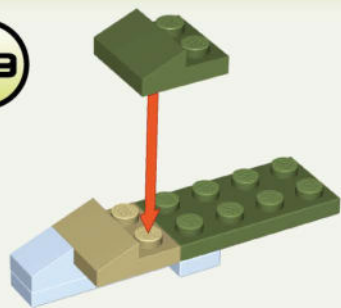

110

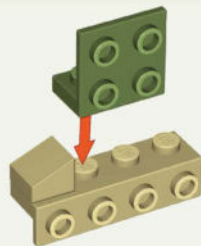

111

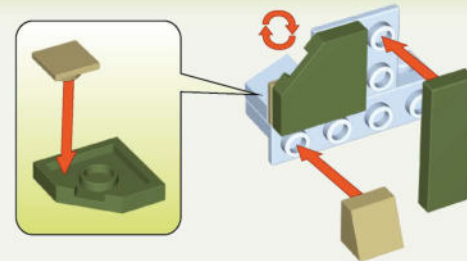

1:1

112

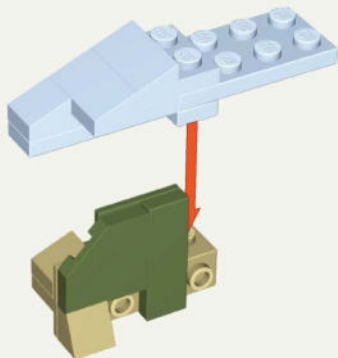





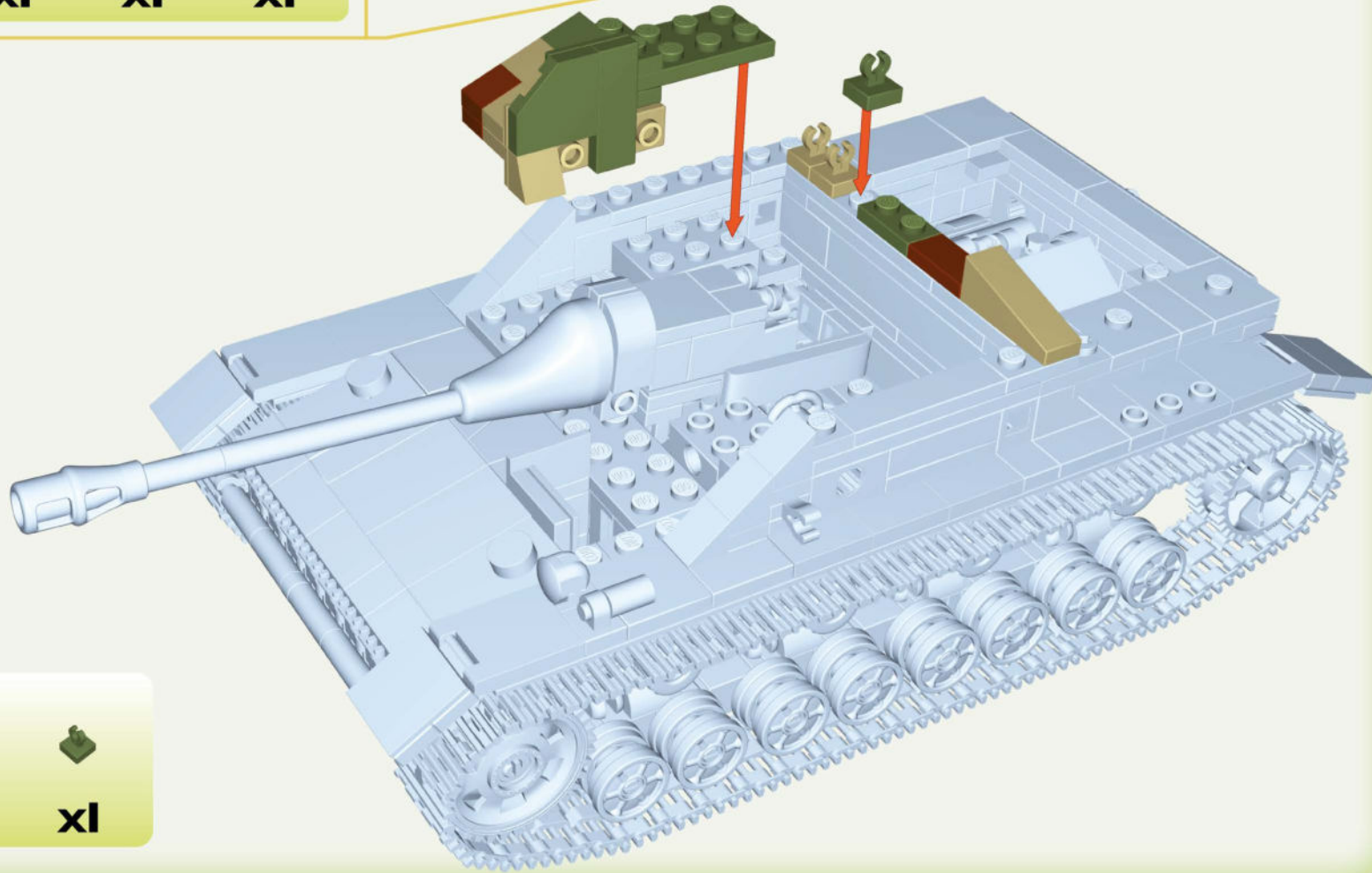

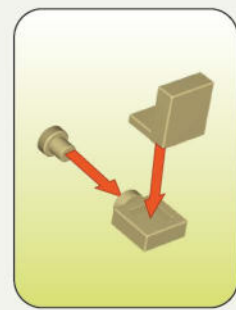
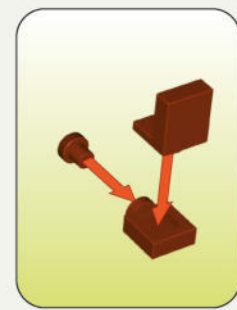
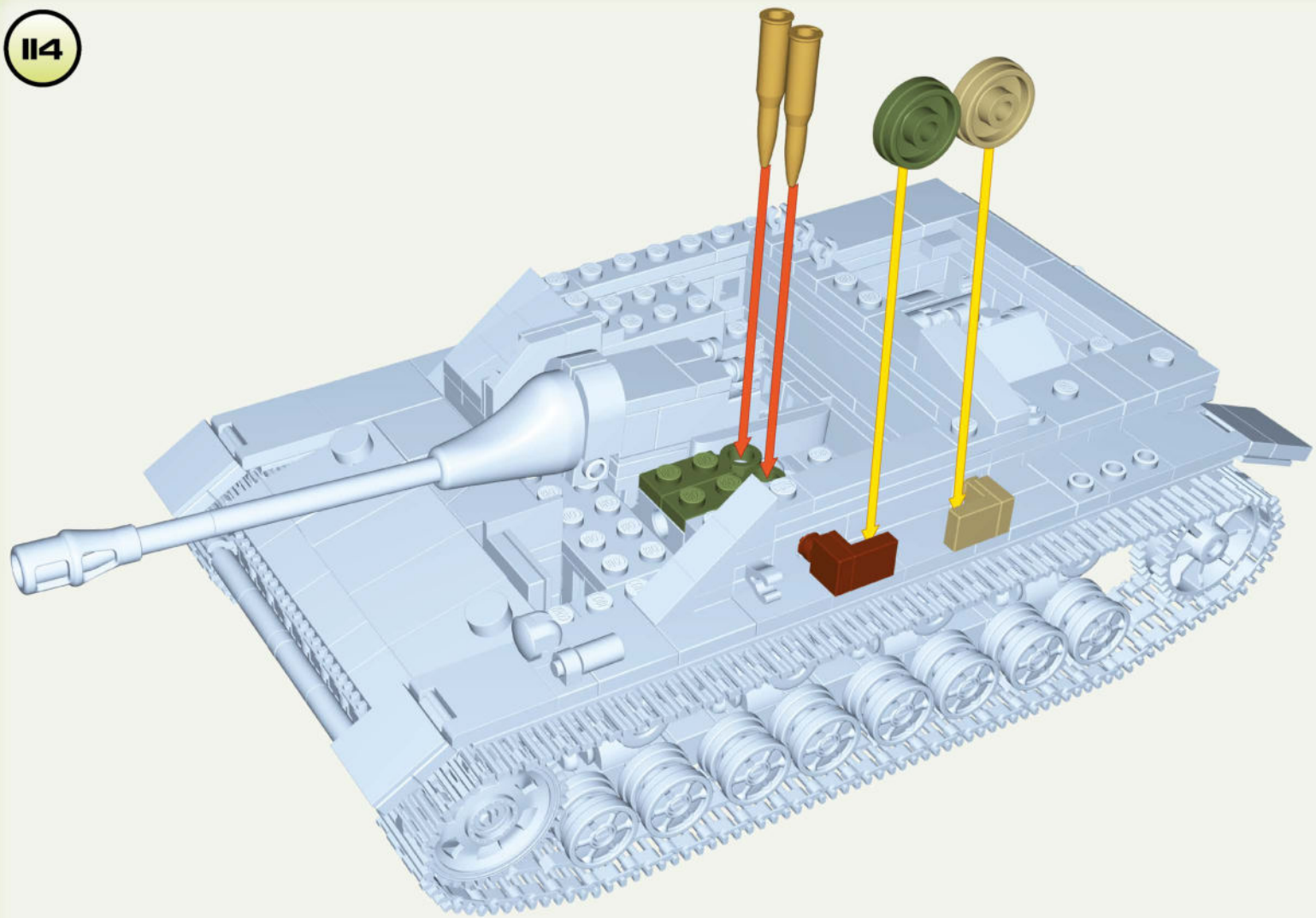



113

1:1





- |   |   |   |   |   |
|---|---|---|---|---|
|  |  |  |  |  |
| <b>x2</b>   | <b>x1</b>   | <b>x1</b>   | <b>x2</b>   | <b>x1</b>   |
|  |  |  |  |  |
| <b>x1</b>   | <b>x1</b>   | <b>x1</b>   | <b>x1</b>   | <b>x1</b>   |



115

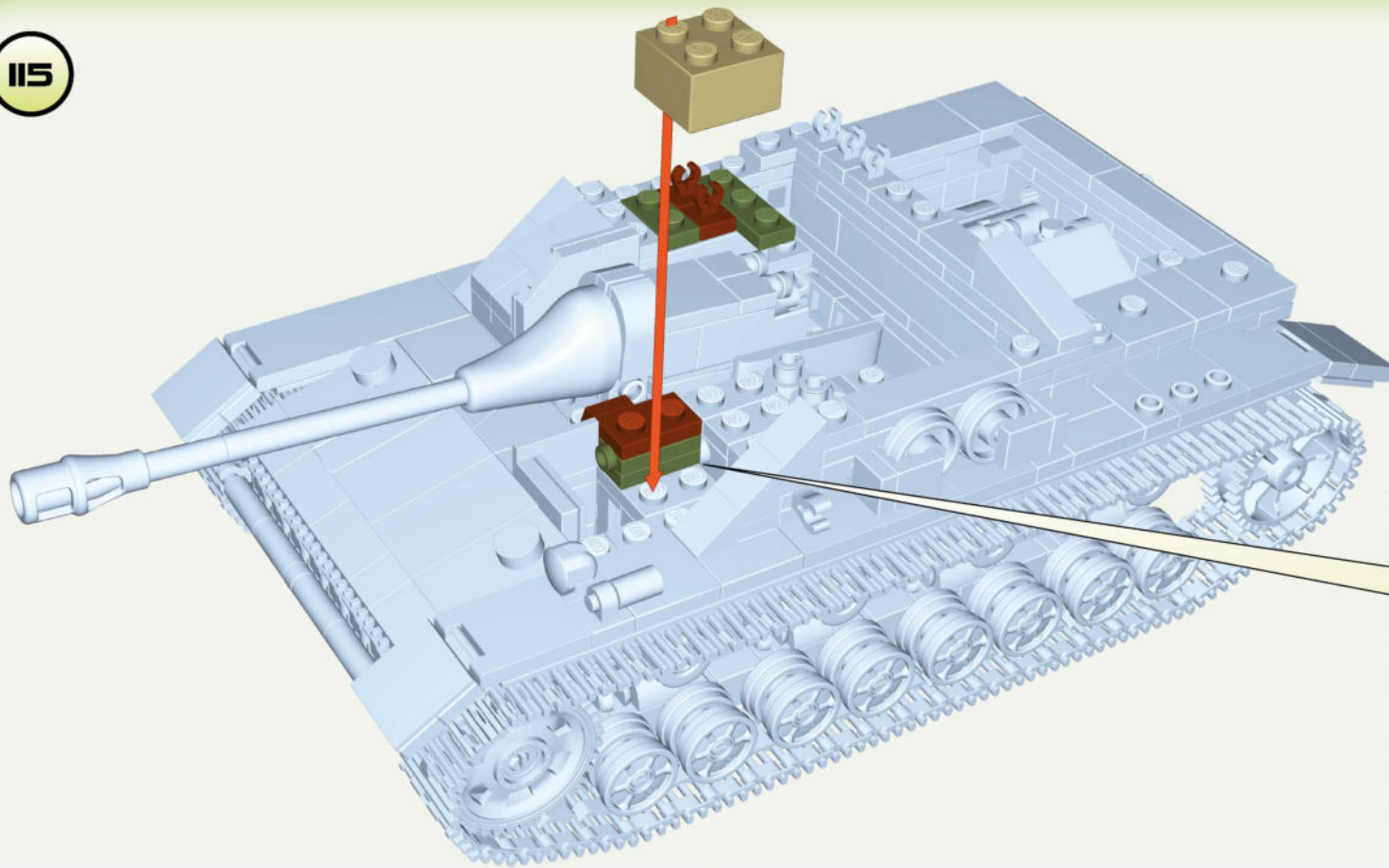

- |    |    |    |    |
|----|----|----|----|
|    |    |    |    |
| x1 | x2 | x2 | x1 |
|    |    |    |    |
| x1 | x1 | x1 | x1 |

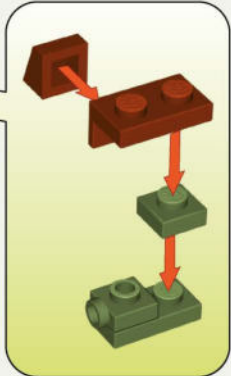

116

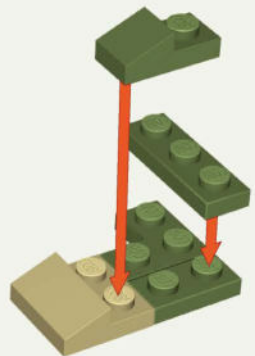

- |    |    |    |    |    |
|----|----|----|----|----|
|    |    |    |    |    |
| x1 | x1 | x1 | x1 | x1 |

117

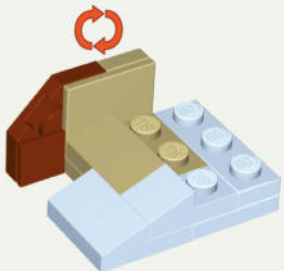
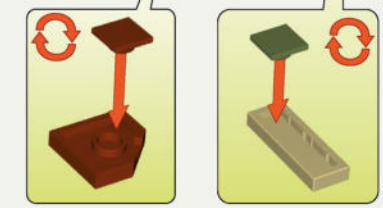
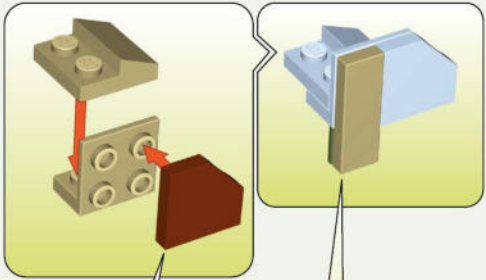

- |    |    |    |    |    |    |
|----|----|----|----|----|----|
|    |    |    |    |    |    |
| x1 | x1 | x1 | x1 | x1 | x1 |

1:1



118

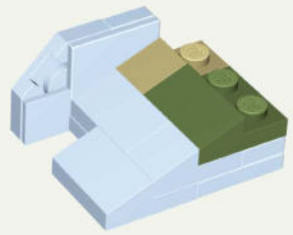

tan 1x1 brick **x1**    green 1x2 brick **x1**



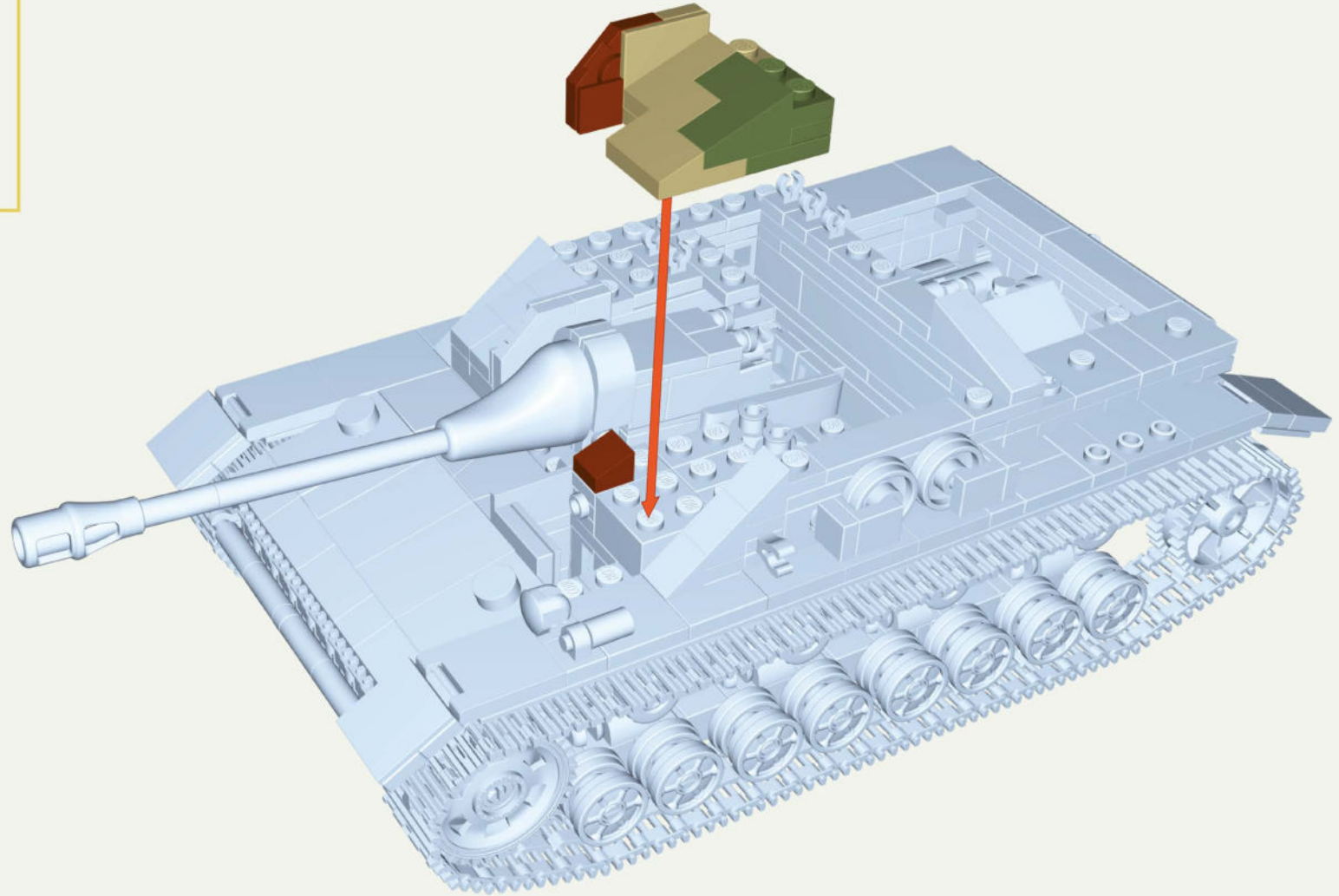



119

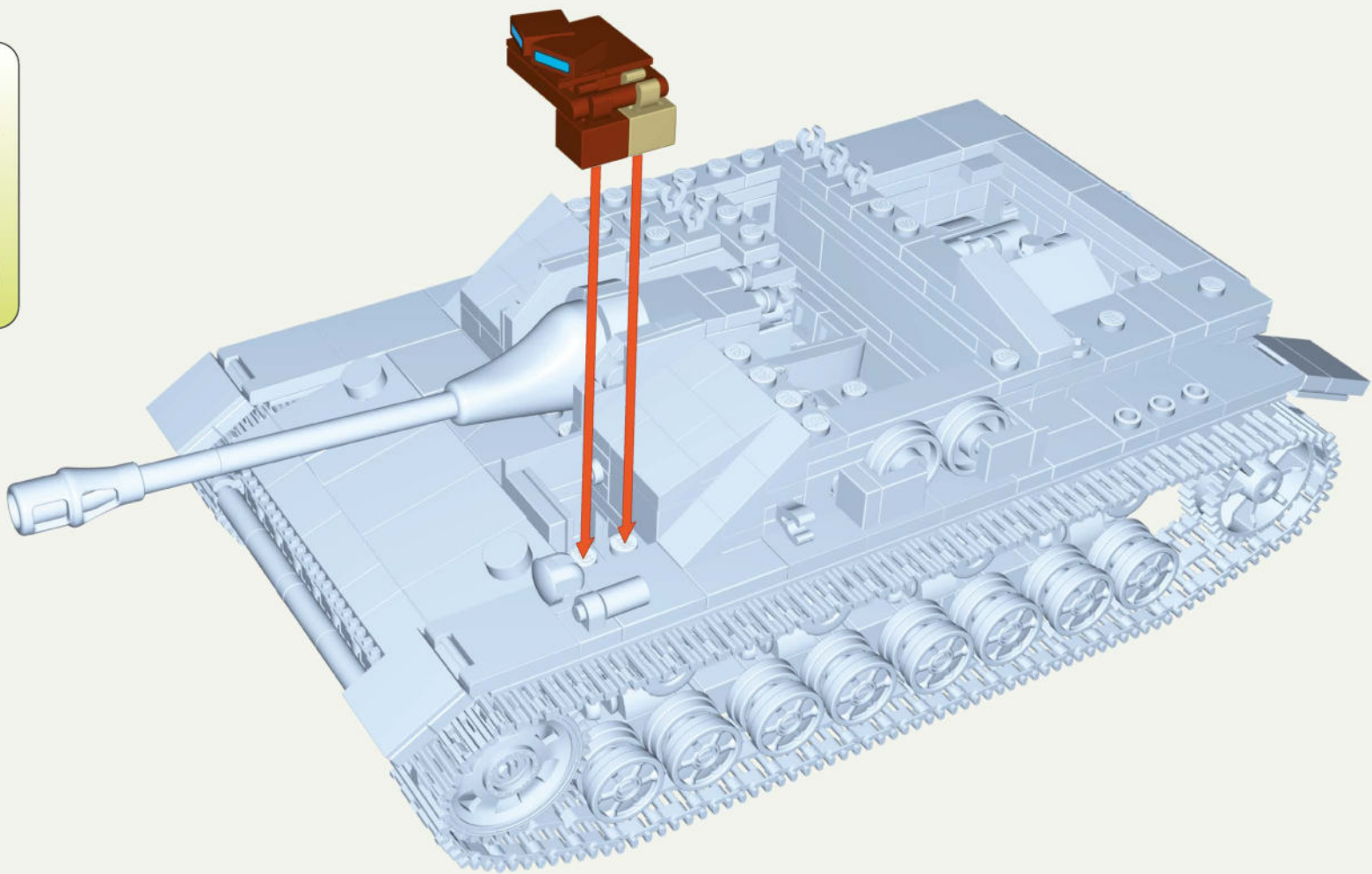
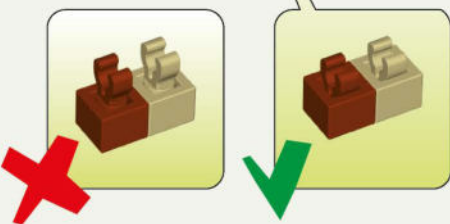
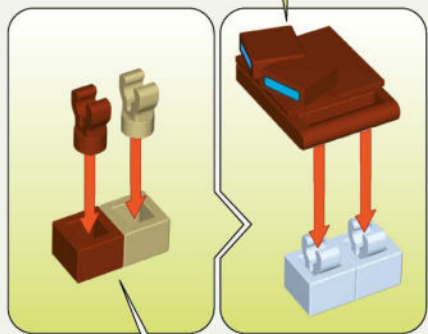
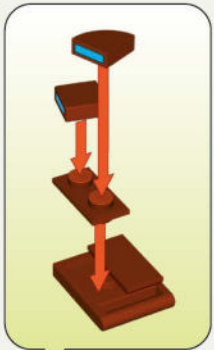

red 1x1 brick **x1**





- |    |    |    |    |    |
|----|----|----|----|----|
|    |    |    |    |    |
| x1 | x1 | x1 | x1 | x1 |
|    |    |    |    |    |
| x1 | x1 | x1 | x1 |    |

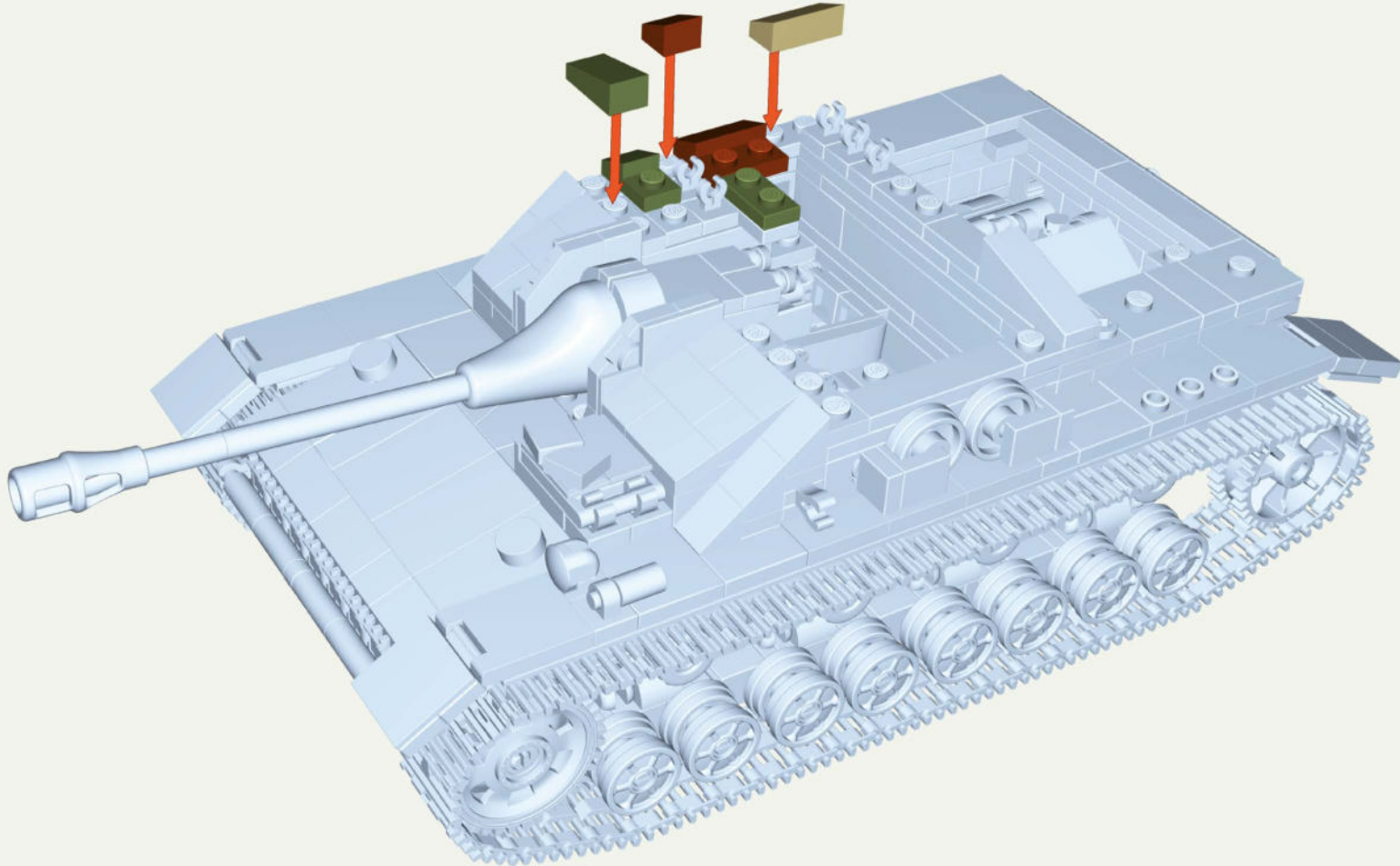

-  **x1**
-  **x1**
-  **x1**
-  **x1**
-  **x1**
-  **x1**





			
<b>x1</b>	<b>x1</b>	<b>x1</b>	<b>x1</b>

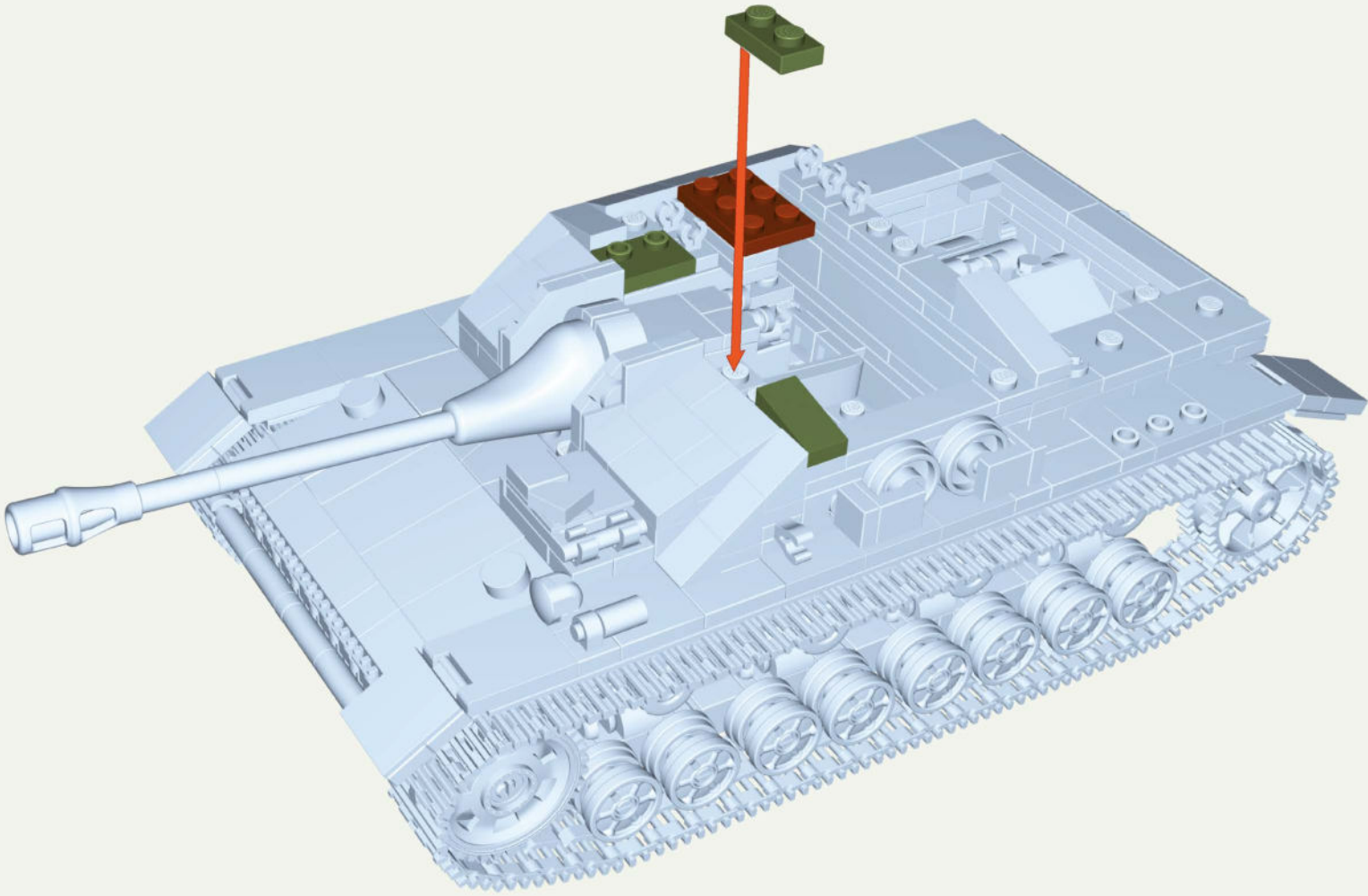

1:1

1:1

-  **x1**
-  **x1**
-  **x1**
-  **x1**
-  **x1**
-  **x1**
-  **x1**
-  **x1**
-  **x1**

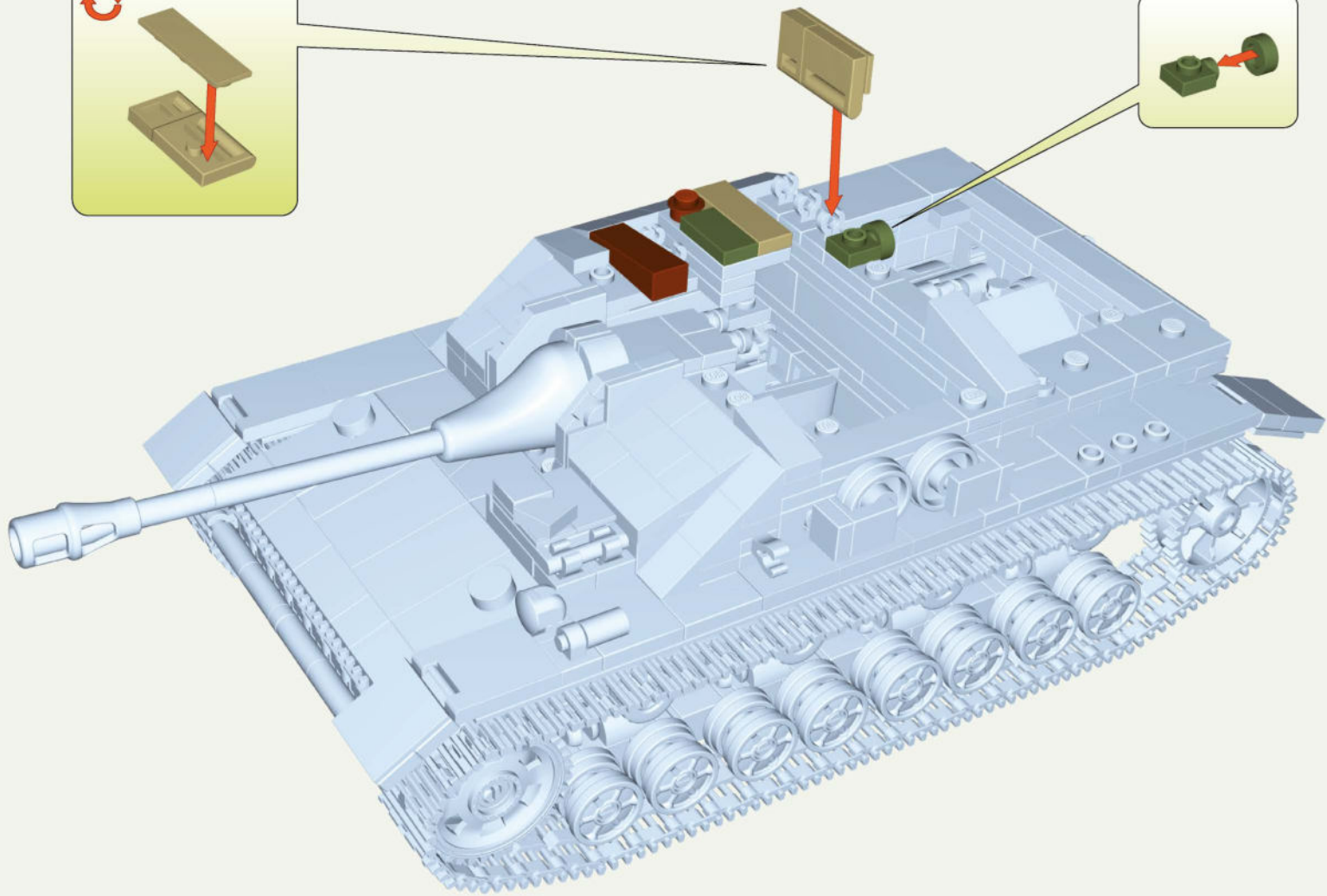
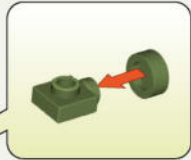
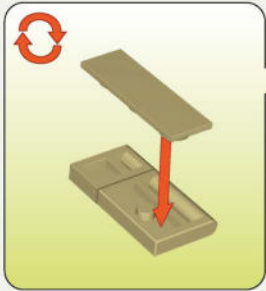

1:1

1:1

-  **x1**
-  **x1**
-  **x1**
-  **x1**
-  **x1**

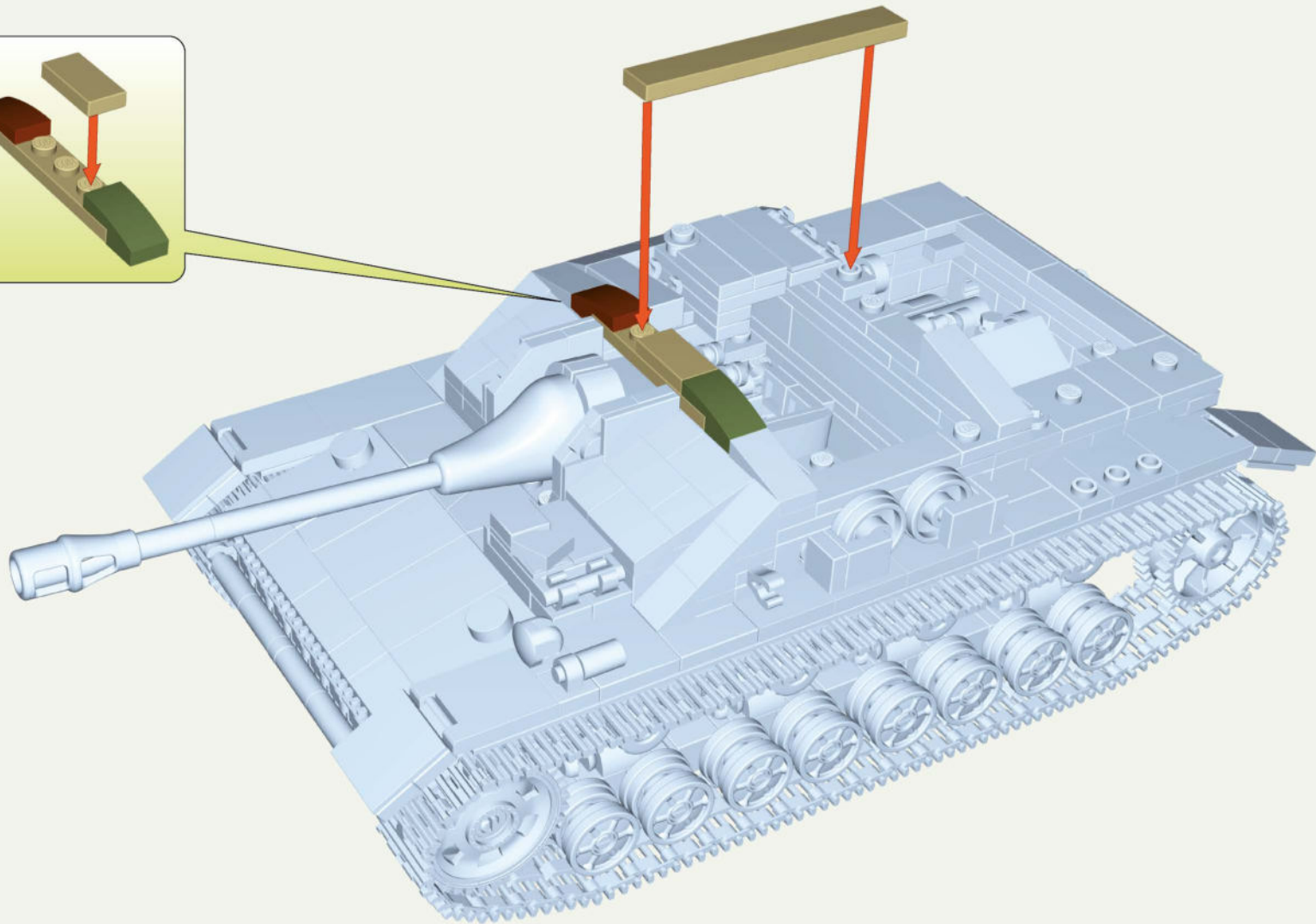
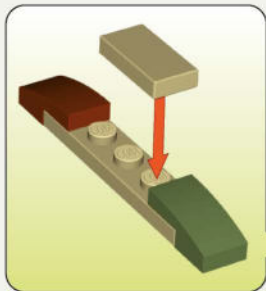



-  **x1**
-  **x1**
-  **x1**
-  **x1**
-  **x1**
-  **x1**
-  **x1**

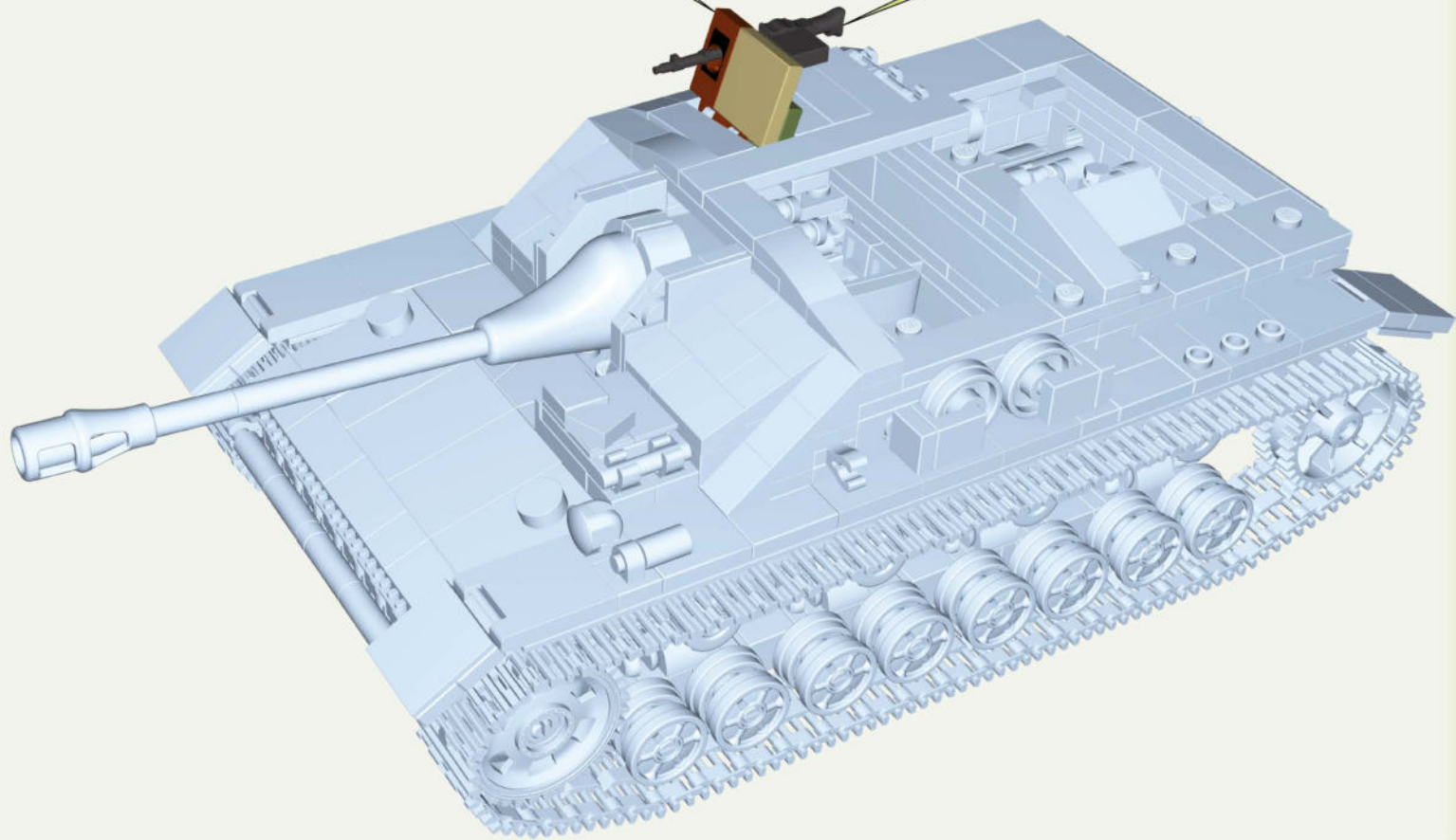
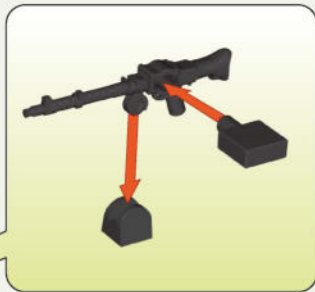
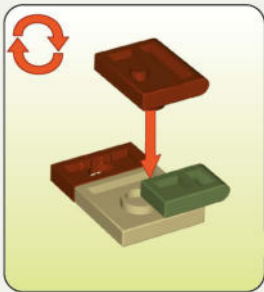
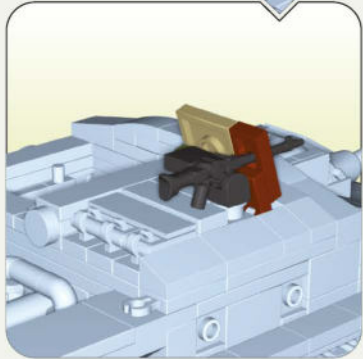
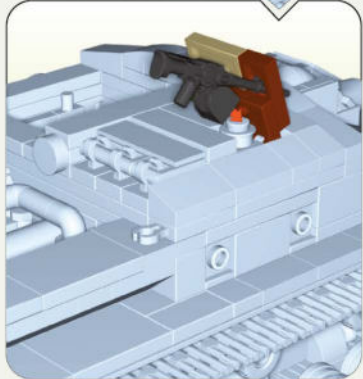
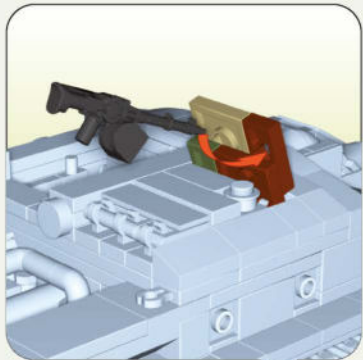

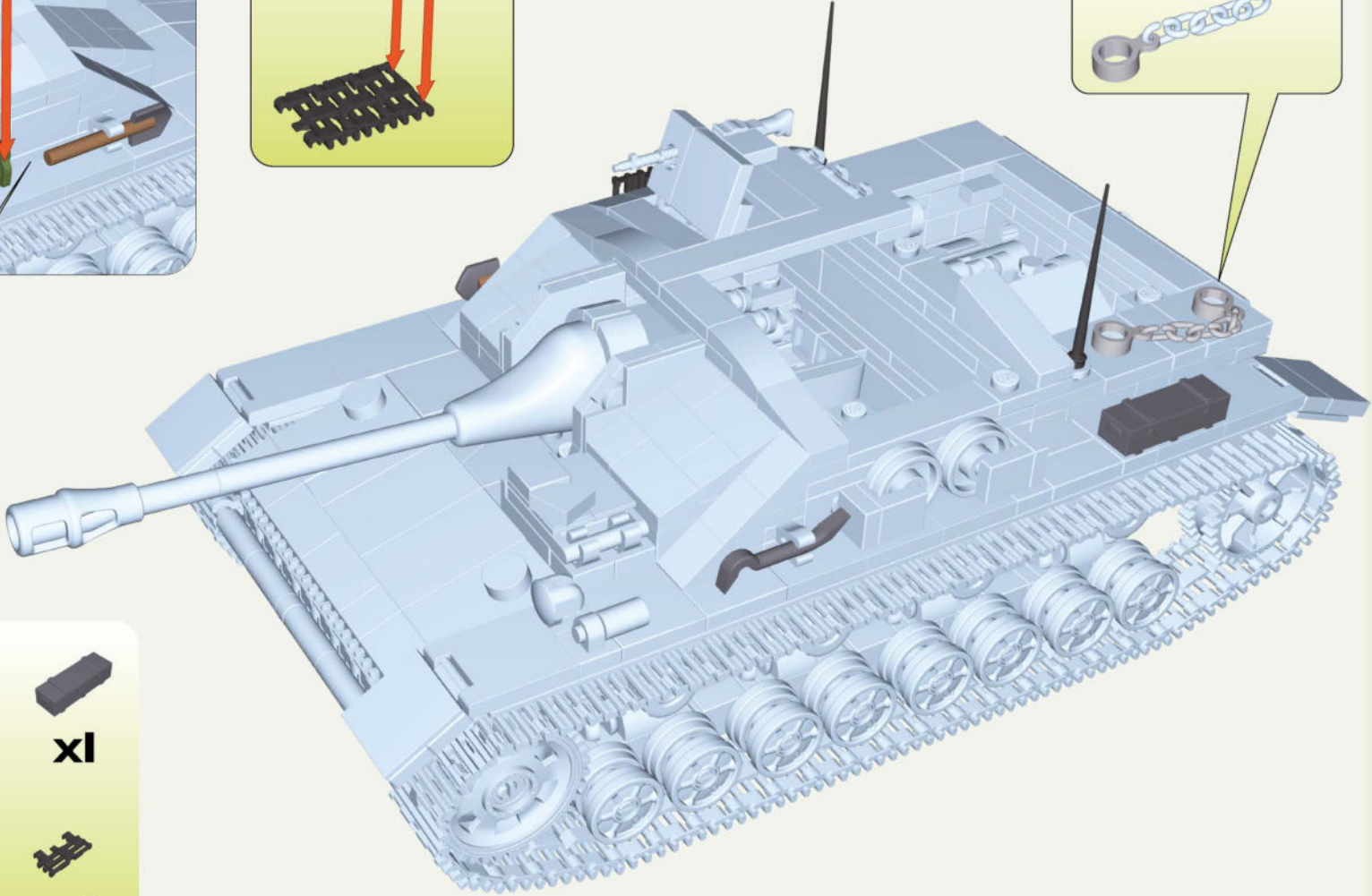
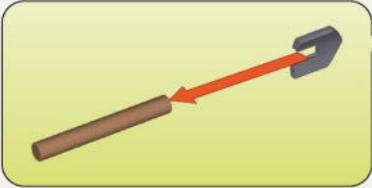
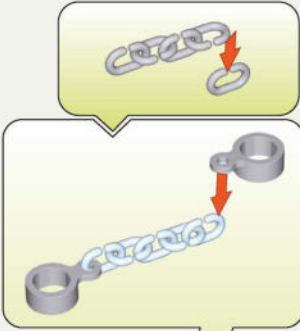
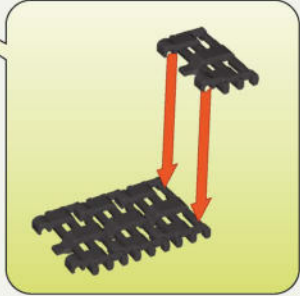
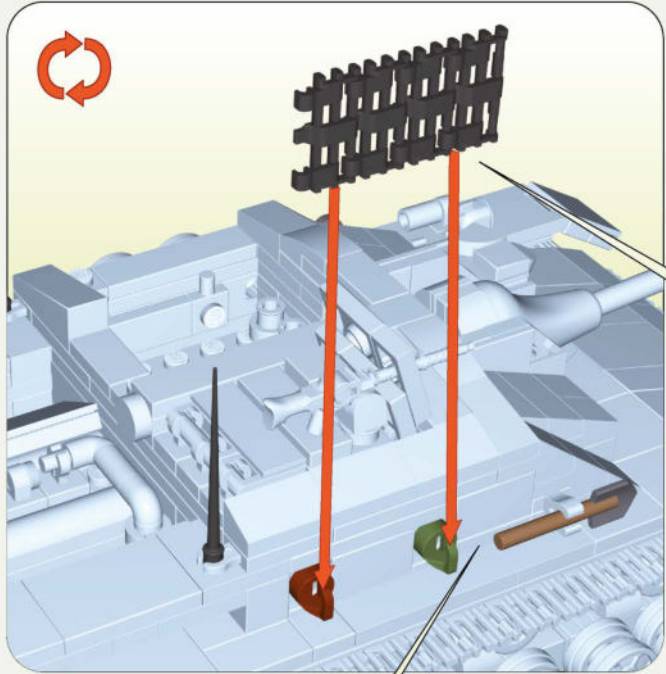

- |   |   |   |   |   |
|---|---|---|---|---|
|  |  |  |  |  |
| x1  | x2  | x1  | x1  | x1  |
|  |  |  |  |  |
| x1  | x1  | x5  | x2  | x4  |

127



1:1



128

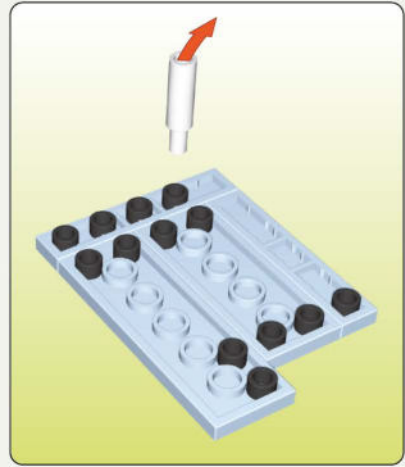
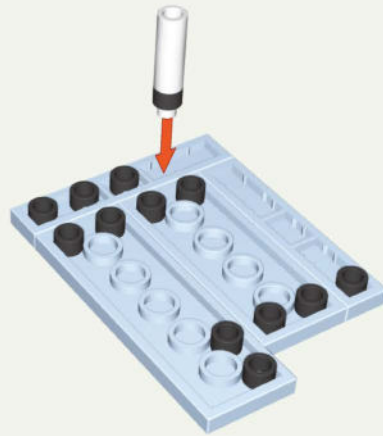

129

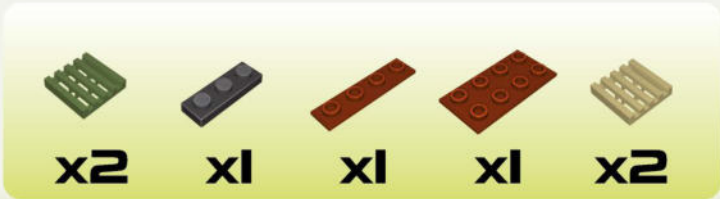
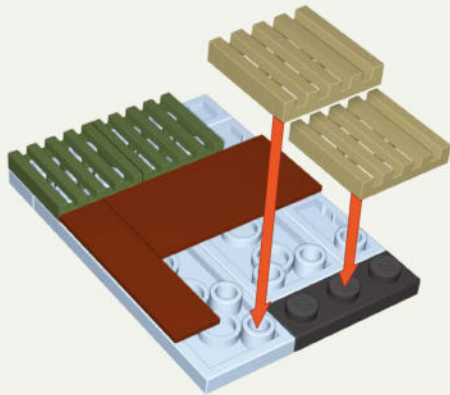

130

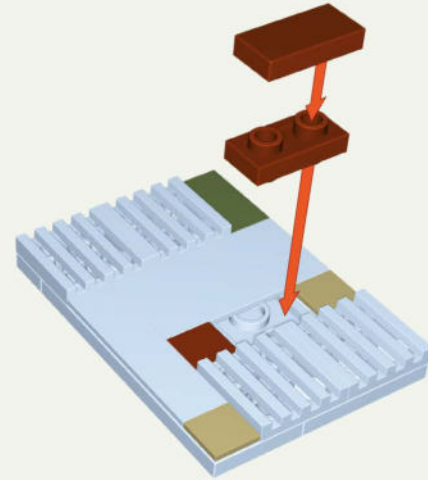

1:1





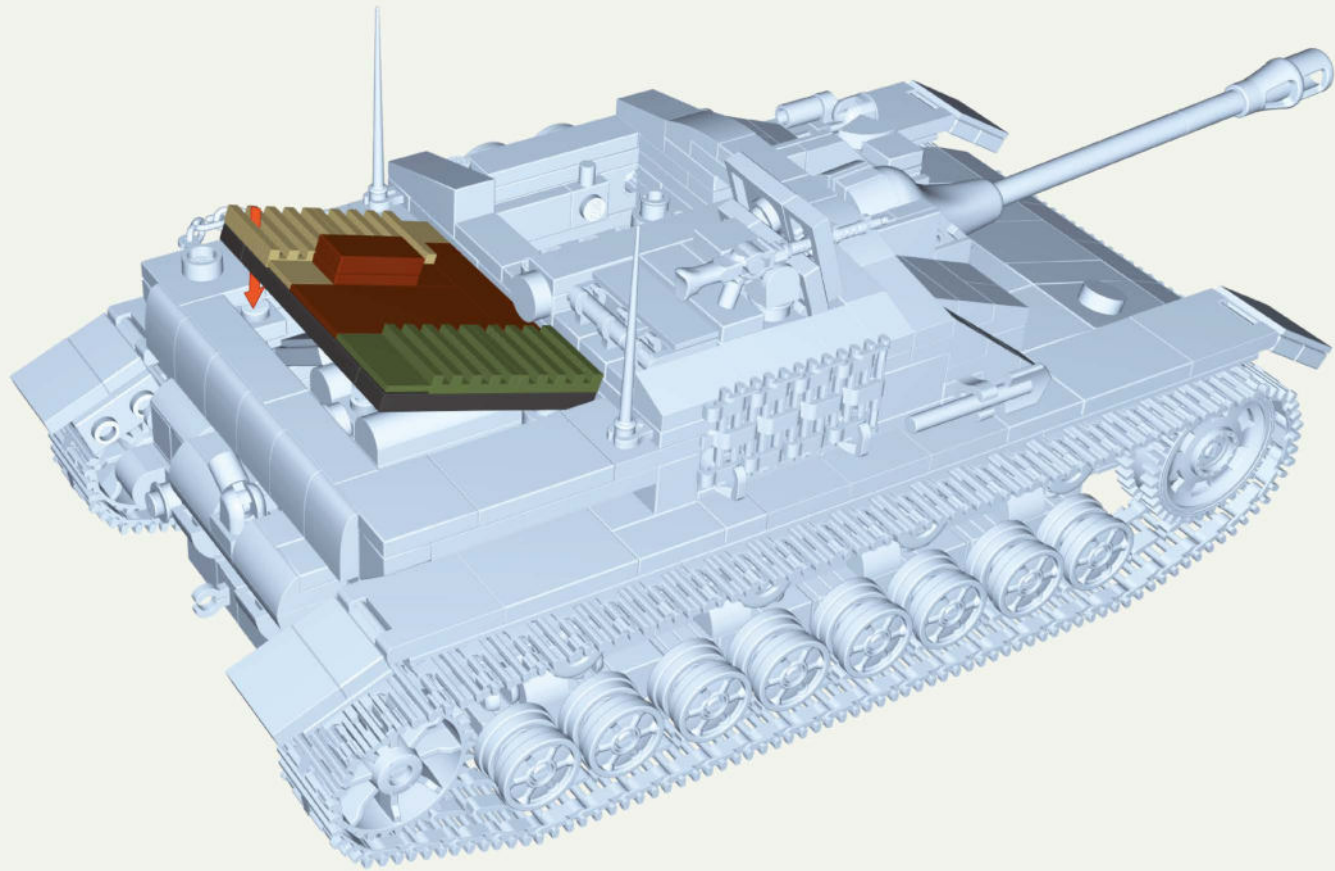

132

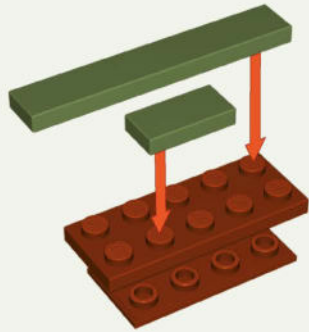

1:1      1:1

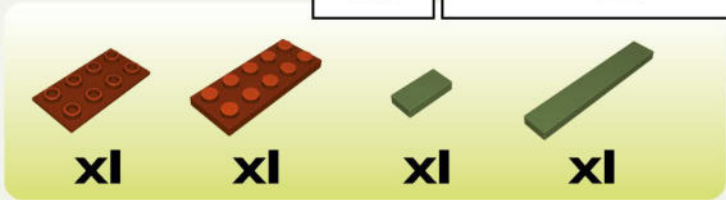

133

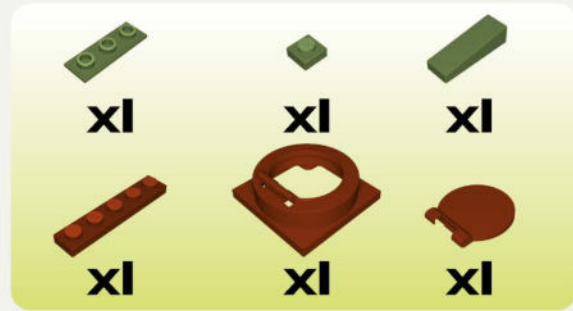
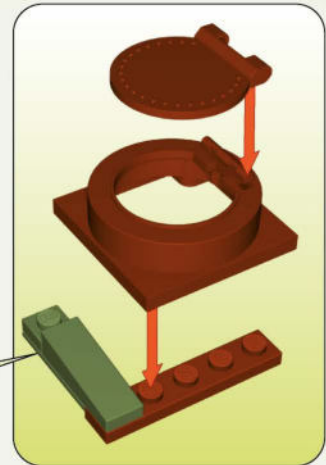
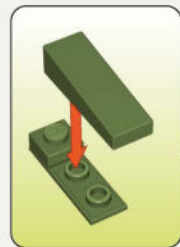
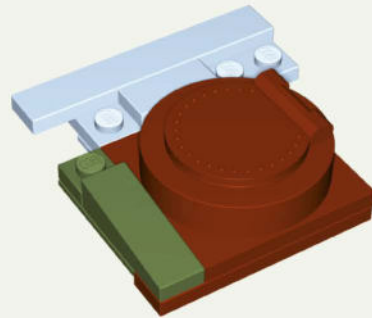



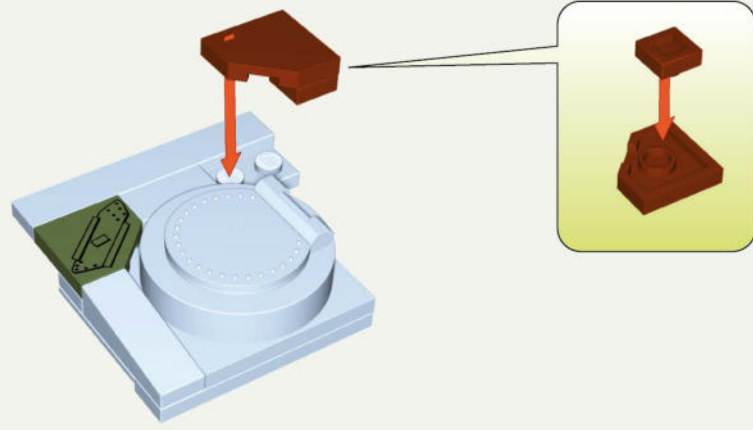

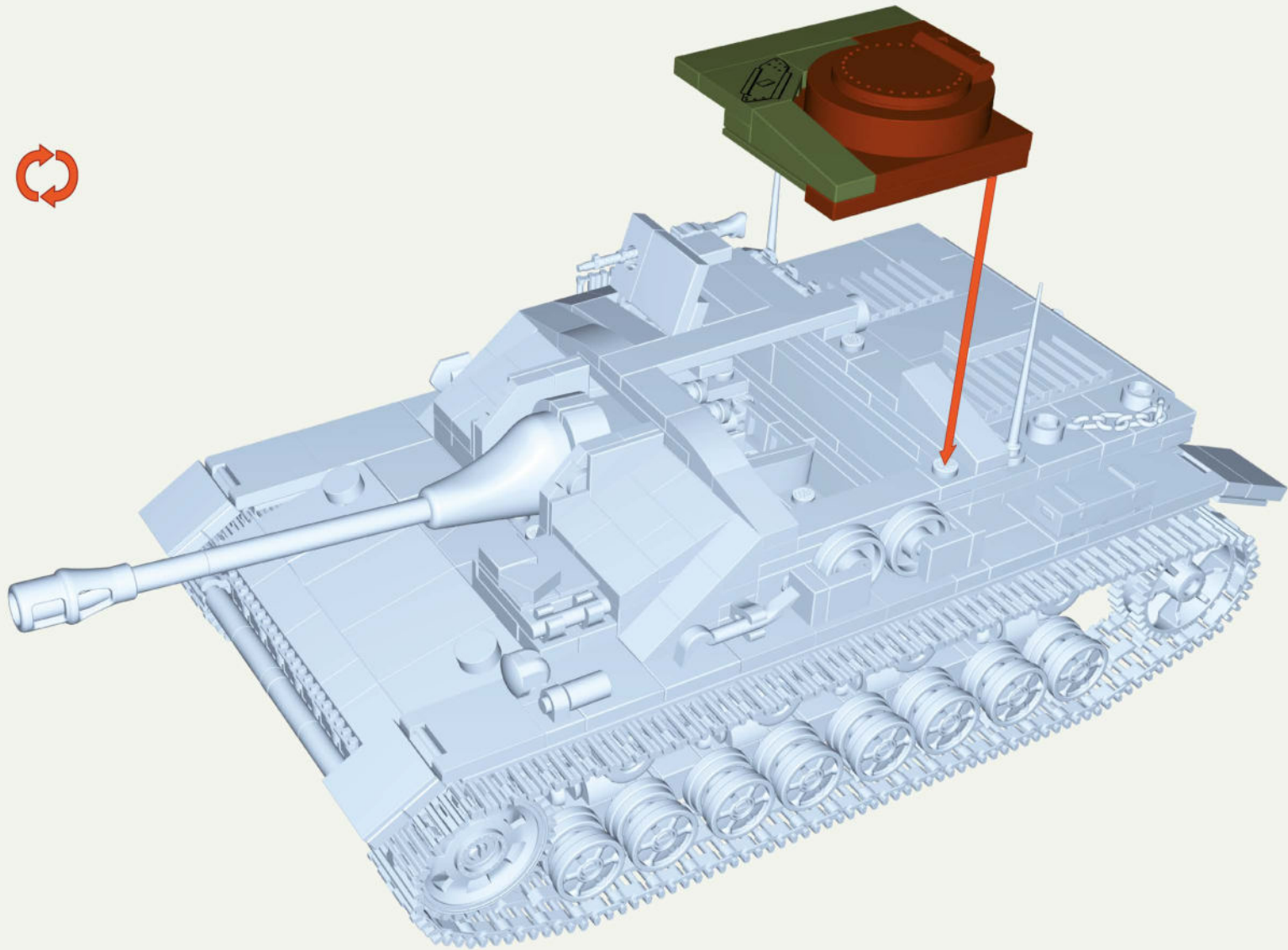







































































































































134







 x2 148879	 x2 157995	 x2 155985	 x2 155433	 x1 128622	 x2 136415	 x1 155036	 x1 155040	 x3 157996	 x1 157997	 x3 97446	 x12 44014	 x1 54631	 x1 155119
 x1 157847	 x1 148876	 x2 86093	 x1 109854	 x1 104128	 x1 119497	 x3 104433	 x1 80459	 x3 77422	 x1 152444	 x2 105092	 x1 152442	 x1 154987	 x1 110007
 x1 128409	 x1 157999	 x2 125256	 x1 127156	 x1 124064	 x3 155012	 x2 96797	 x1 157848	 x5 53169	 x1 52994	 x1 43668	 x2 128408	 x2 98923	 x1 96758
 x1 100990	 x2 119720	 x1 158000	 x1 154949	 x4 150425	 x2 147699	 x1 145256	 x3 155106	 x1 148832	 x2 157988	 x1 152387	 x4 146137	 x1 155141	 x1 130627
 x1 155120	 x2 97505	 x1 44969	 x2 44879	 x4 155122	 x1 105894	 x12 93052	 x1 155111	 x1 104432	 x3 42863	 x3 157998	 x1 128470	 x1 155434	 x1 112793
 x4 97493	 x1 157989	 x2 92239	 x2 156864	 x1 142267	 x1 125894	 x2 57213	 x3 105895	 x2 155100	 x2 44169	 x1 155105	 x2 104427	 x3 99232	 x1 157851
 x1 157849	 x1 157850	 x2 108584	 x2 157990	 x1 132984	 x3 155009	 x1 157991	 x1 128527	 x2 120783	 x1 111084	 x1 155152	 x1 157992	 x10 155978	 x2 153389
 x1 155140	 x3 97495	 x21 42931	 x3 51554	 x3 43671	 x7 154999	 x1 157937	 x1 42913	 x2 157936	 x2 79560	 x2 97936	 x1 42922	 x1 155159	 x1 113533
 x1 113934	 x1 157938	 x2 128416	 x1 106765	 x3 155436	 x2 106764	 x1 124067	 x1 157853	 x5 97447	 x6 45540	 x1 45448	 x2 155109	 x1 97499	 x3 94039
 x3 155610	 x1 125376	 x13 150432	 x1 148827	 x7 132329	 x1 155153	 x2 91750	 x1 60322	 x5 42952	 x1 117804	 x2 148878	 x3 106342	 x2 155114	 x2 104434

 x2 83632	 x1 157939	 x1 128968	 x2 157935	 x3 42895	 x2 157994	 x15 42905	 x1 112869	 x1 155045	 x2 111484	 x2 157940	 x2 81905	 x1 155150	 x1 154970
 x4 111481	 x1 155110	 x1 157972	 x3 132618	 x1 157973	 x1 113942	 x1 107729	 x1 157974	 x4 97496	 x1 42957	 x5 42959	 x1 57130	 x2 155000	 x1 97458
 x1 93457	 x1 157854	 x2 155107	 x3 148820	 x4 115502	 x2 155156	 x1 154943	 x1 44877	 x1 157975	 x1 147990	 x1 157976	 x3 109733	 x1 155101	 x4 97457
 x1 45208	 x5 42976	 x1 105051	 x1 42985	 x3 42991	 x3 157977	 x1 157979	 x2 157978	 x1 97459	 x1 155050	 x7 157980	 x7 91991	 x6 156897	 x1 128274
 x1 117836	 x1 42967	 x2 157855	 x1 125344	 x1 157861	 x1 157981	 x1 85406	 x1 157982	 x2 128844	 x6 148707	 x2 148706	 x2 97475	 x5 67985	 x2 155089
 x2 90219	 x1 135762	 x1 117805	 x3 43017	 x1 83478	 x1 43006	 x1 157983	 x2 128843	 x4 155443	 x1 97506	 x3 74222	 x1 156904	 x2 97468	 x1 97472
 x1 155076	 x10 43048	 x1 157993	 x3 43041	 x1 128121	 x1 98207	 x1 43084	 x1 51597	 x1 43685	 x1 157986	 x1 99305	 x2 105867	 x5 43100	 x1 53201
 x1 112618	 x1 108154	 x2 97502	 x1 43114	 x2 156874	 x2 54893	 x2 156831	 x2 128413	 x4 111485	 x4 155077	 x1 45467	 x1 155147	 x1 157856	 x2 157987
 x1 118379	 x1 77561	 x1 156885	 x2 79715	 x2 148825	 x7 124559	 x6 156862	 x1 43687	 x2 157941	 x1 151230	 x1 155167	 x1 157985	 x1 43057	 x1 104131
 x1 97481	 x1 62886	 x1 158001	 x1 117451	 x1 155103	 x1 67979	 x1 45452	 x1 138843	 x4 97487	 x4 43154	 x2 155088	 x1 97489	 x1 86989	 x2 155054









FIELD KITCHEN (HF.14)

+ 2290



H.M.C M8 SCOTT

★ 2279



MARDER III Ausf. M

+ 2282



Sd.Kfz. 251/9 "STUMMEL"

+ 2283



10,5cm leFH 18

+ 2292



Sd.Kfz.7 HALF-TRACK

+ 2275

Sd.Kfz.7 HALF-TRACK

+ 2275

# HISTORICAL COLLECTION